













Mehr Produkte finden Sie  
in unserem Katalog!

Art.-Nr. 534 211



#### DIMENSIONEN

|   |                                |                     |
|---|--------------------------------|---------------------|
|   | Bohlenstärke                   | 34 mm               |
|   | Innenmaß                       | 293 x 233 cm        |
|   | Sockelmaß                      | 430 x 240 cm        |
|   | Gesamtmaß                      | 480 x 300 cm        |
|   | Grundfläche                    | 10,3 m <sup>2</sup> |
|   | Seitendach                     | 150 cm              |
|   | Rauminhalt                     | 20,8 m <sup>3</sup> |
|   | Seitenwandhöhe v/h             | 217/205 cm          |
|   | Dachüberstand<br>umlaufend     | 30 cm               |
|   | Dachneigung                    | 4 °                 |
|   | Dachfläche                     | 14,4 m <sup>2</sup> |
|   | Dachbretter<br>inkl. Dachpappe | 18 mm               |
|  | Fußboden                       | 18 mm               |

#### TÜR

|  |                        |              |
|--|------------------------|--------------|
|  | Doppeltür<br>(Volholz) | 143 x 186 cm |
|--|------------------------|--------------|

#### VERPACKUNG

|  |               |                   |
|--|---------------|-------------------|
|  | Paketmaß      |                   |
|  | Paket 1       | 407 x 117 x 60 cm |
|  | Paket 2       | 200 x 100 x 20 cm |
|  | Gesamtgewicht | 865 kg            |

#### ZUBEHÖR

4 Rollen Dichtungsbahnen  
**Dachrinne**  
Kunststoff 404Ax anthrazit  
Alu bis 600 cm  
mit 1 Fallrohr

## Pulti 34-B Typ 1 mit SD A

34 mm | 430 x 240 cm | 10,3 m<sup>2</sup>

**5** JAHRE  
GARANTIE



Die UVP-Preise finden Sie in der Preisliste oder unter:  
[www.finnhaus.de/downloads.php](http://www.finnhaus.de/downloads.php)

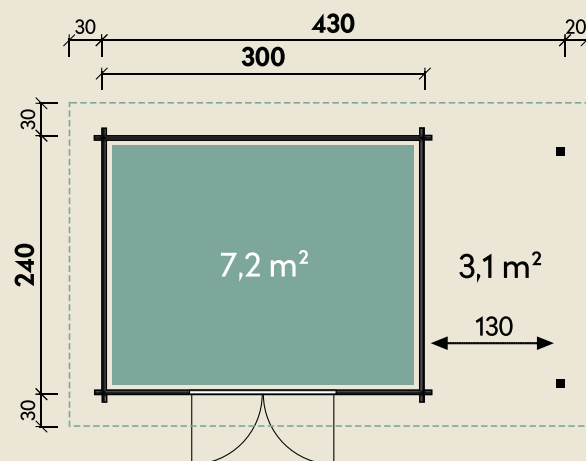

Alle Preise sind empfohlene Verkaufspreise inklusive der gesetzlichen MwSt.  
Weitere Informationen finden Sie unter: [www.finnhaus.de](http://www.finnhaus.de) oder im aktuellen Katalog.  
Technische Änderungen, Druckfehler und Irrtümer vorbehalten.