

Technische Daten

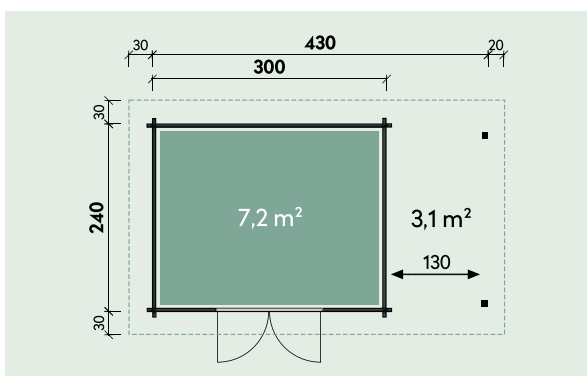

Artikelnummer:

534 350 ist Bestandteil von
534 214



Kontrolliert durch:

Technische Daten

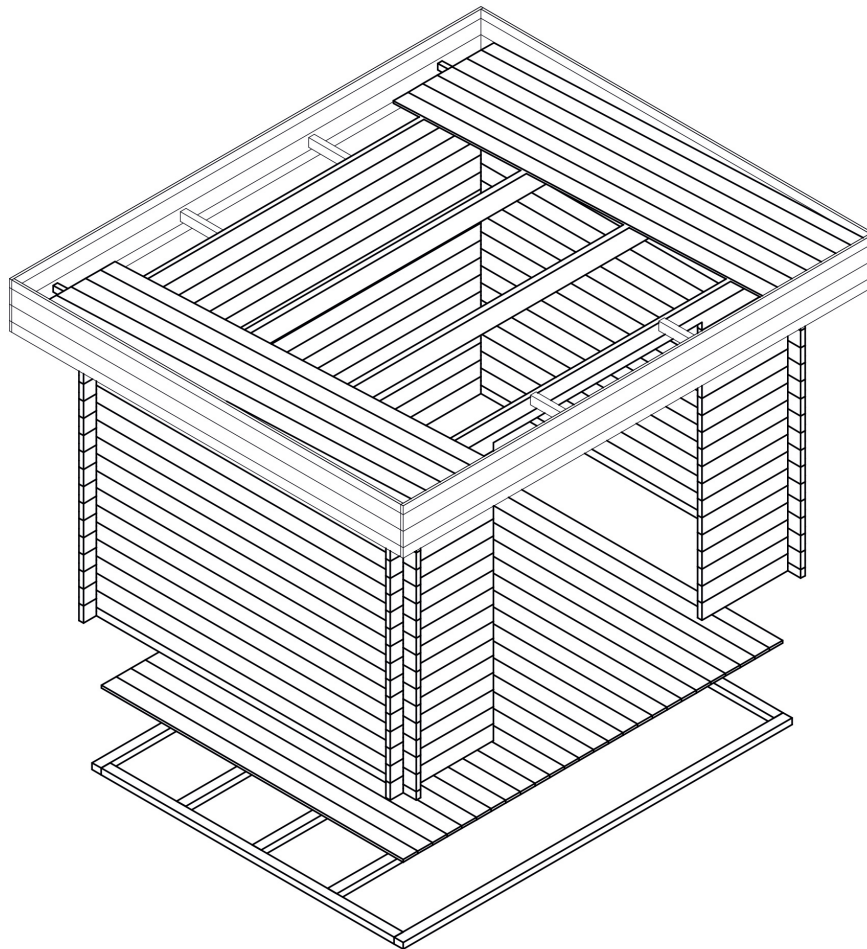

534 350

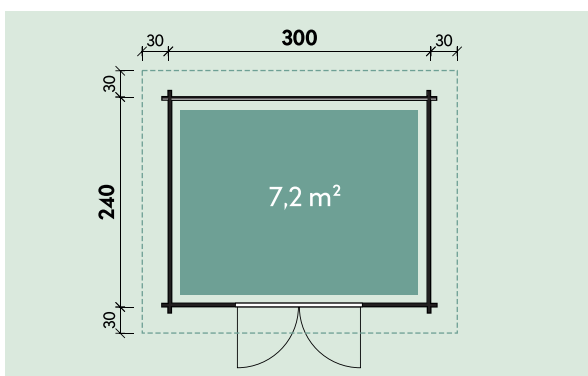

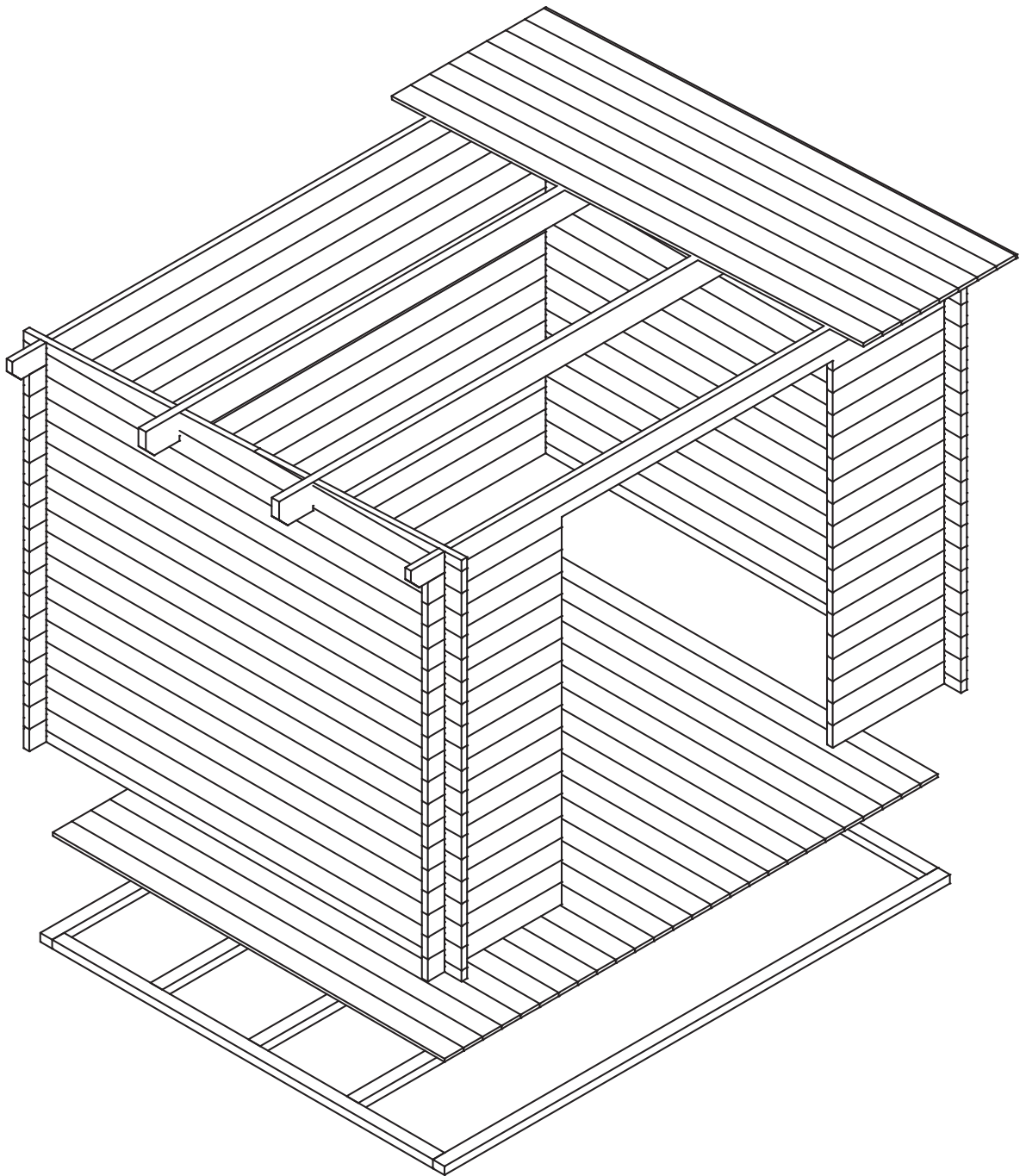

Kontrolliert durch:

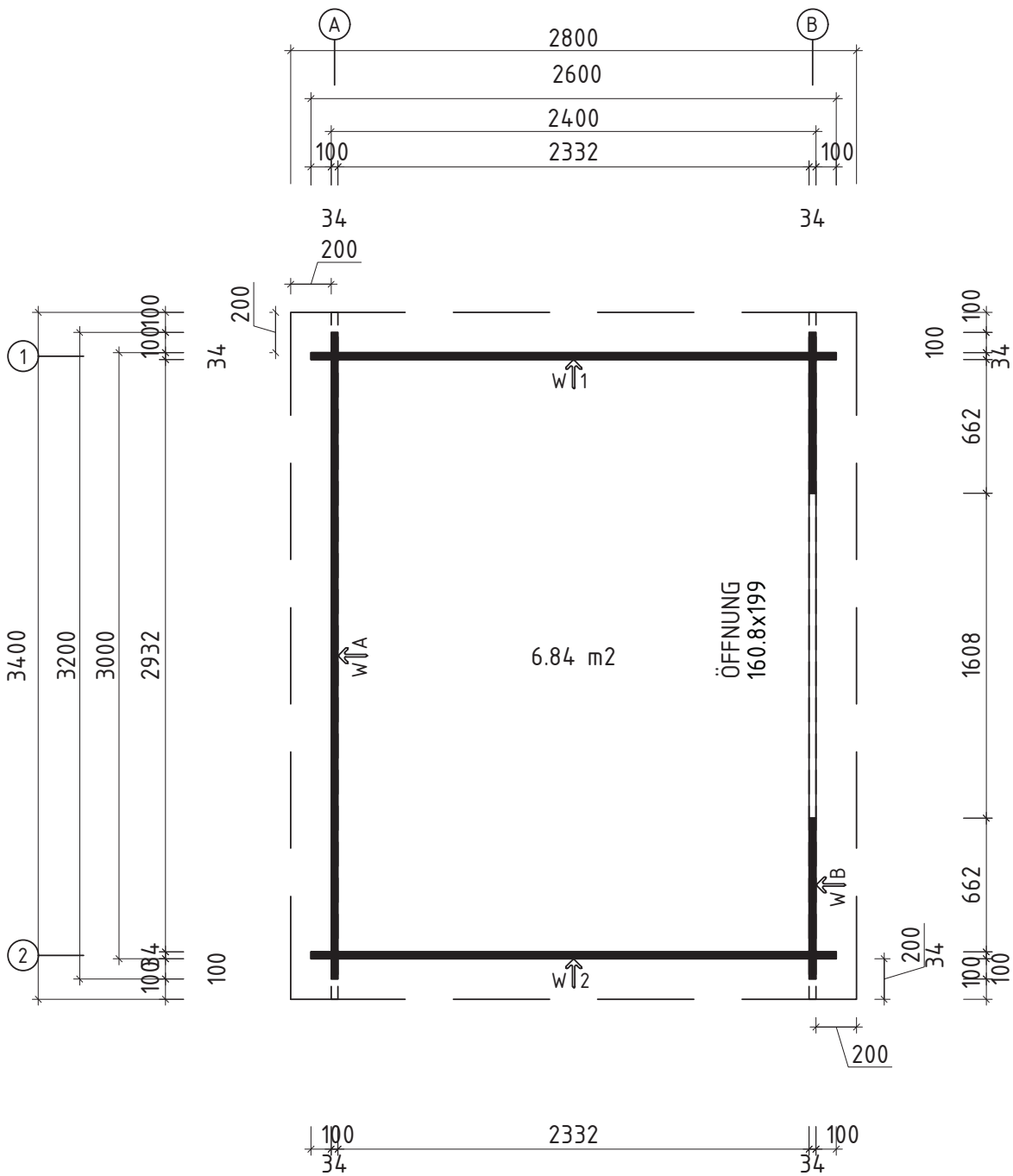

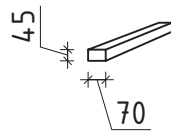
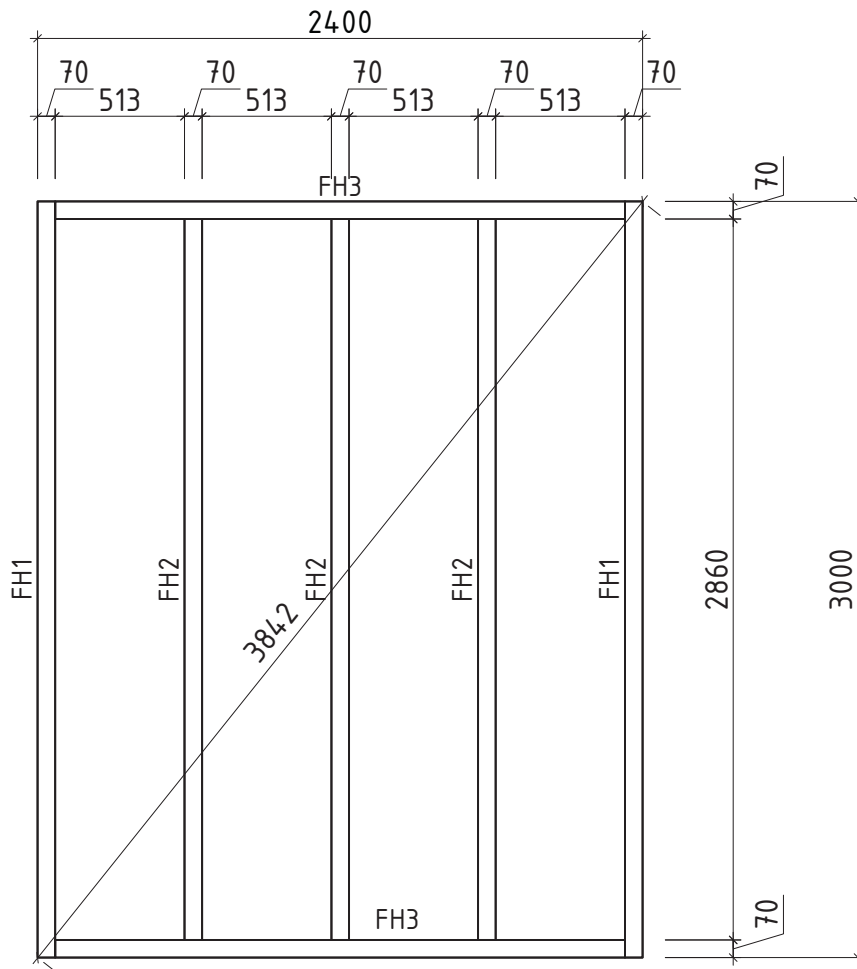

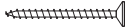
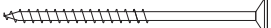
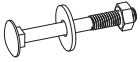
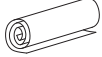

Pos	Teilleiste Pulti B ohne Tür_34	Stck	Profil (mm)	Länge (mm)
001		1	34x109	3400
002		1	34x114	3400
003		1	34x114	3200
004		17	34x114	3200
006		32	34x114	2600
007		2	34x57	2600
009		34	34x114	796
W1-1		1		
W2-1		1		
FH1	FUNDAMENTHÖLZER (imprägniert) 	2	70x45	3000
FH2	FUNDAMENTHÖLZER (imprägniert) 	3	70x45	2860
FH3	FUNDAMENTHÖLZER (imprägniert) 	2	70x45	2260
PF1	PFETTEN 	2	44x145	3400
	DACHBRETTER	31+1	113x18	2805
	FUSSBODENBRETTER	26+1	113x18	2325
	FUSSBODENLEISTEN		18x40	11.0lfm
G02-1	GIEBELBRETT 18x120	2	18x120	2825
G05-1	GIEBELDECKLEISTEN 18x40	2	18x40	2805
T02-1	TRAFENBRETT 18x120	1	18x120	3436
T01-1	TRAFENBRETT 18x95	1	18x95	3400
T04-1	TRAFENDECKLEISTEN 18x40		18x40	3.5lfm
T06-1	TRAFENLEISTEN 18x40		18x40	7.0lfm
SM-1	Sturmleisten	2	18x40	1940
SM-2	Sturmleisten	2	18x40	2050
SH	Schlaghölzer	3		
Kood	Pulti B ohne Tür_34	Materjal	Leht	1/2

Pos	Teileliste Pulti B ohne Tür_34		Stck.	Profil (mm)	Länge (mm)
NG01	DACHPAPPNÄGEL 2.8x15		220		
NG04	NÄGEL 2.5x50	Dachbretter Fussbodenbretter	508		
SR32	SCHRAUBEN 3.0x30	Fussbodenleiste Traufenleiste 40x18 Traufendeckleiste 40x18 Giebeldeckleiste 40x18	55		
SR37	SCHRAUBEN 3.5x45	Traufenbretter 95x18, 120x18 Giebelbretter 18x120	20		
SR57	SCHRAUBEN 5.0x100	Fundamenthölzer	28		
SS024	Schloßschrauben M8x70 Mutter M8 U-Scheibe Ø25 - Befestigung für Sturmleisten		12		
KP-1	DACHPAPPE		✓	3.4m-4st	14.0lfm
	✓ - bitte selber anpassen (falls nötig)!				
Kood	Pulti B ohne Tür_34		Materjal	Leht	2/2

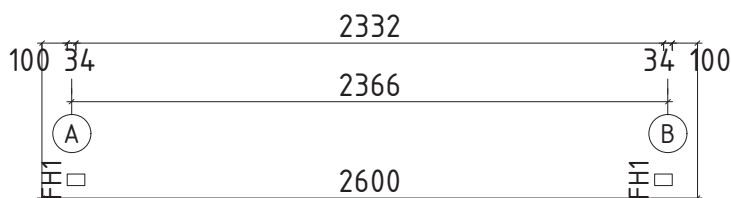
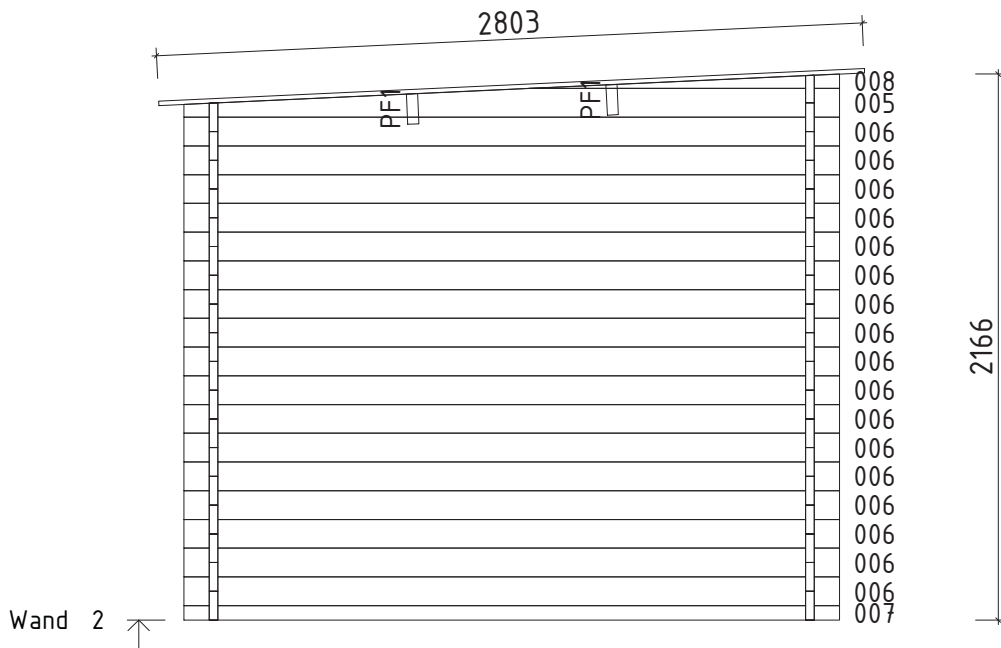
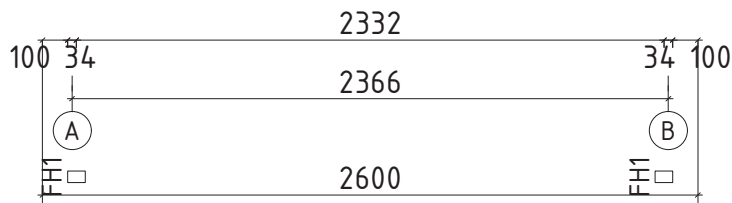
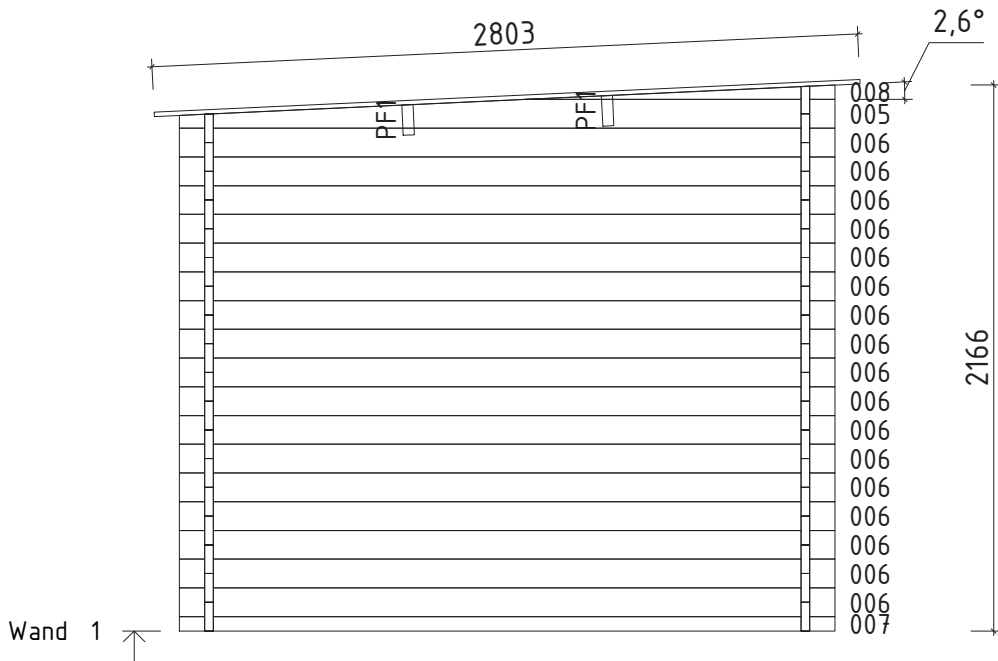

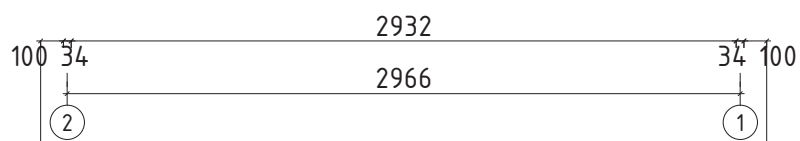
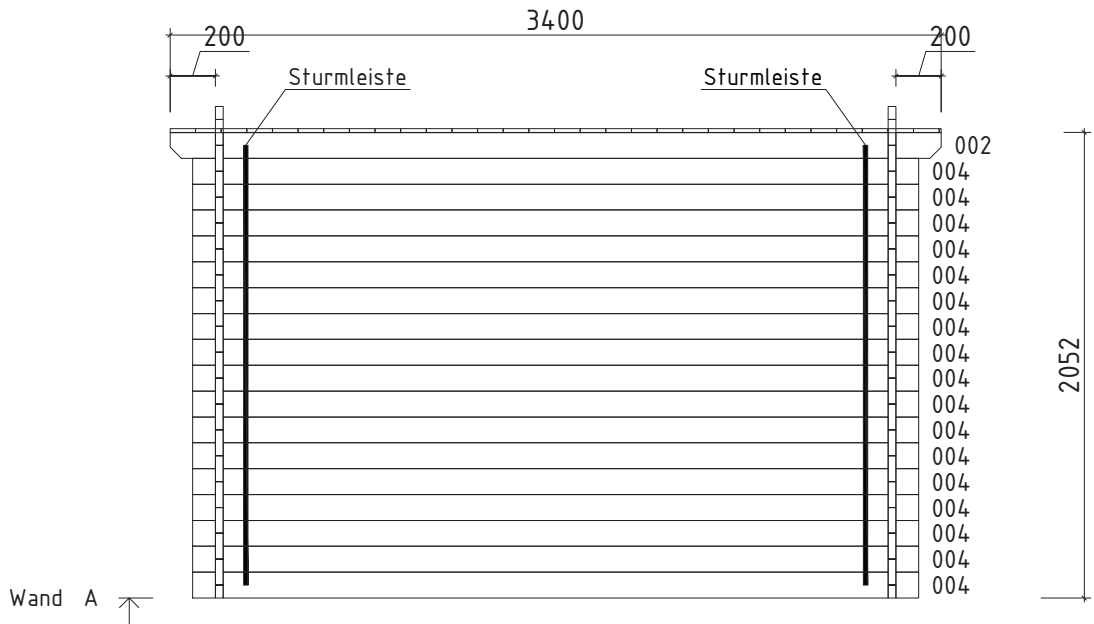
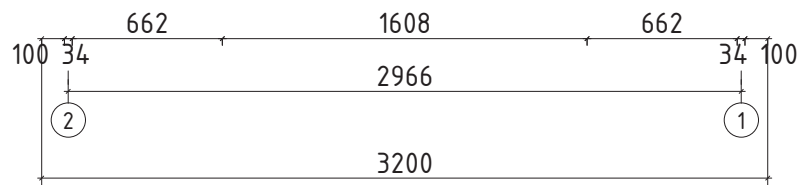
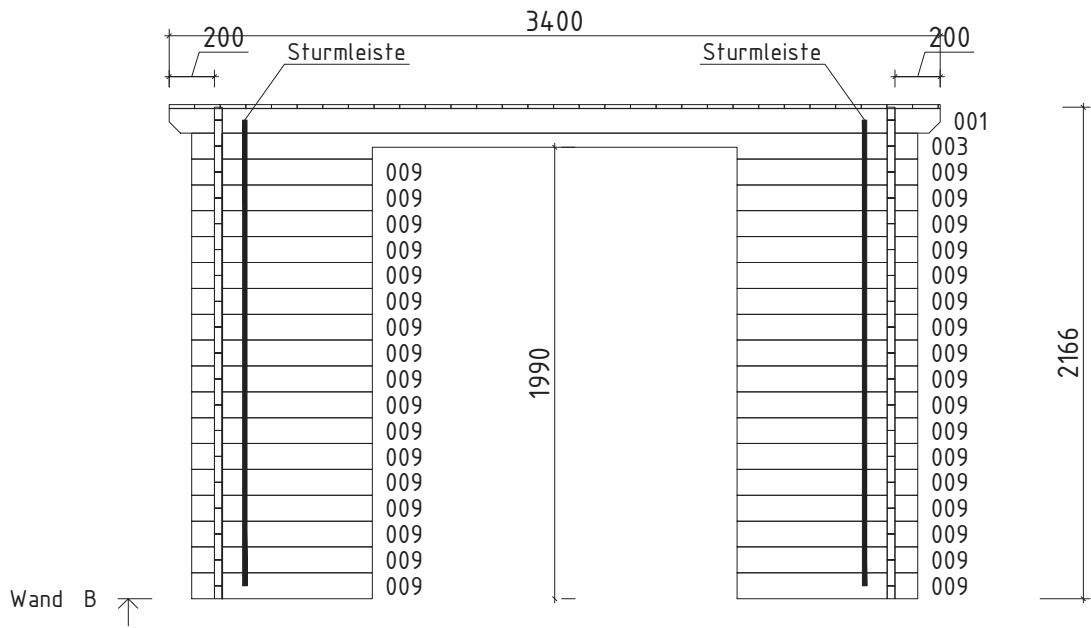

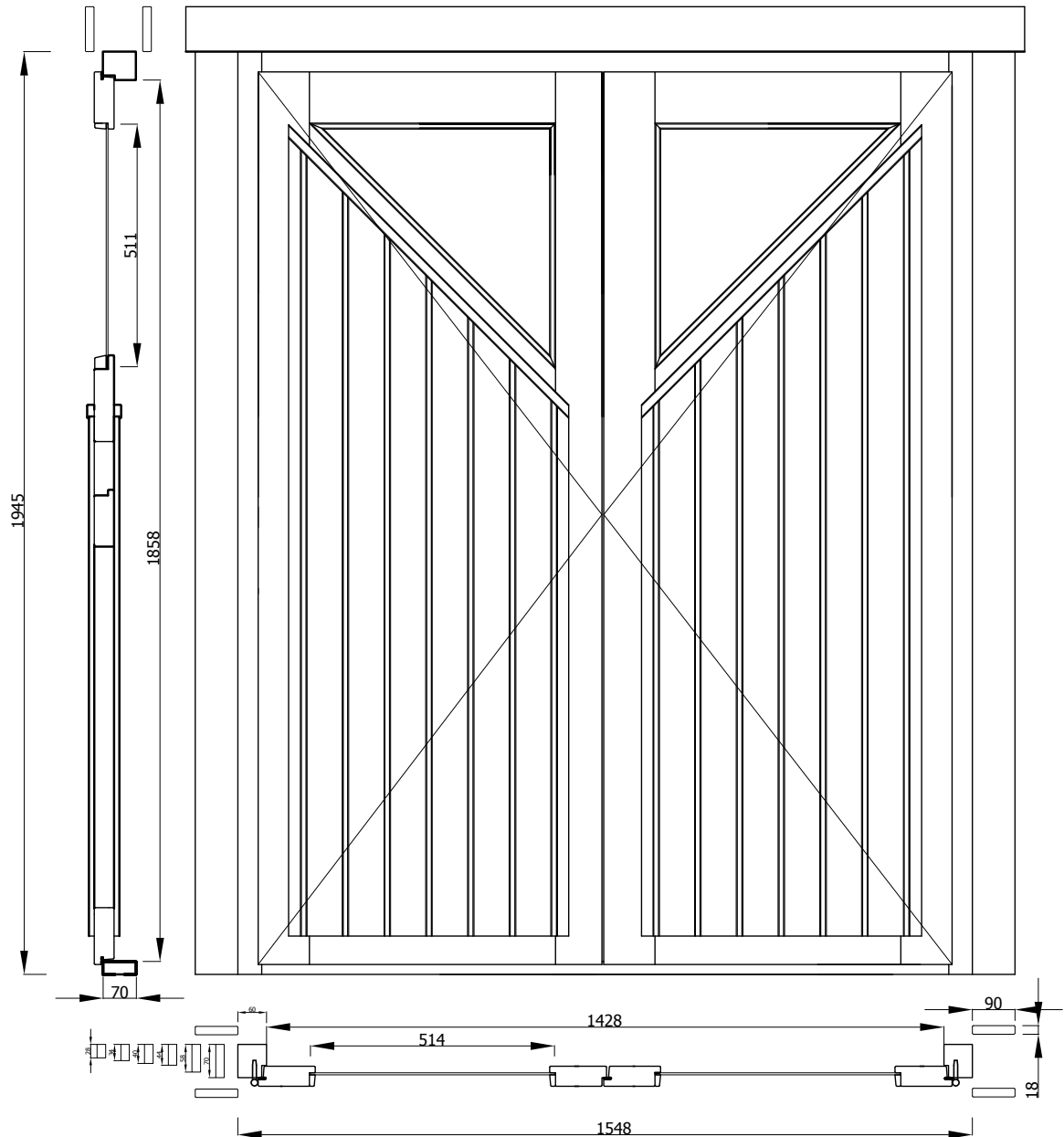

Lochmaß: 1588 x 1965 mm
Rahmenaußenmaß: 1548 x 1945 mm
Durchgangsmaß: 1428 x 1858 mm
Glasmaß: 514 x 511 mm
Glasstärke: 4 mm

Technische Daten: Art.-Nr.: 700 200

Wandaußenmaß: 150 x 300 cm



Kontrolliert durch:

Achtung: Alle angegebenen Maße sind ca.-Maße!

3D-Darstellung Art.-Nr. 700 200

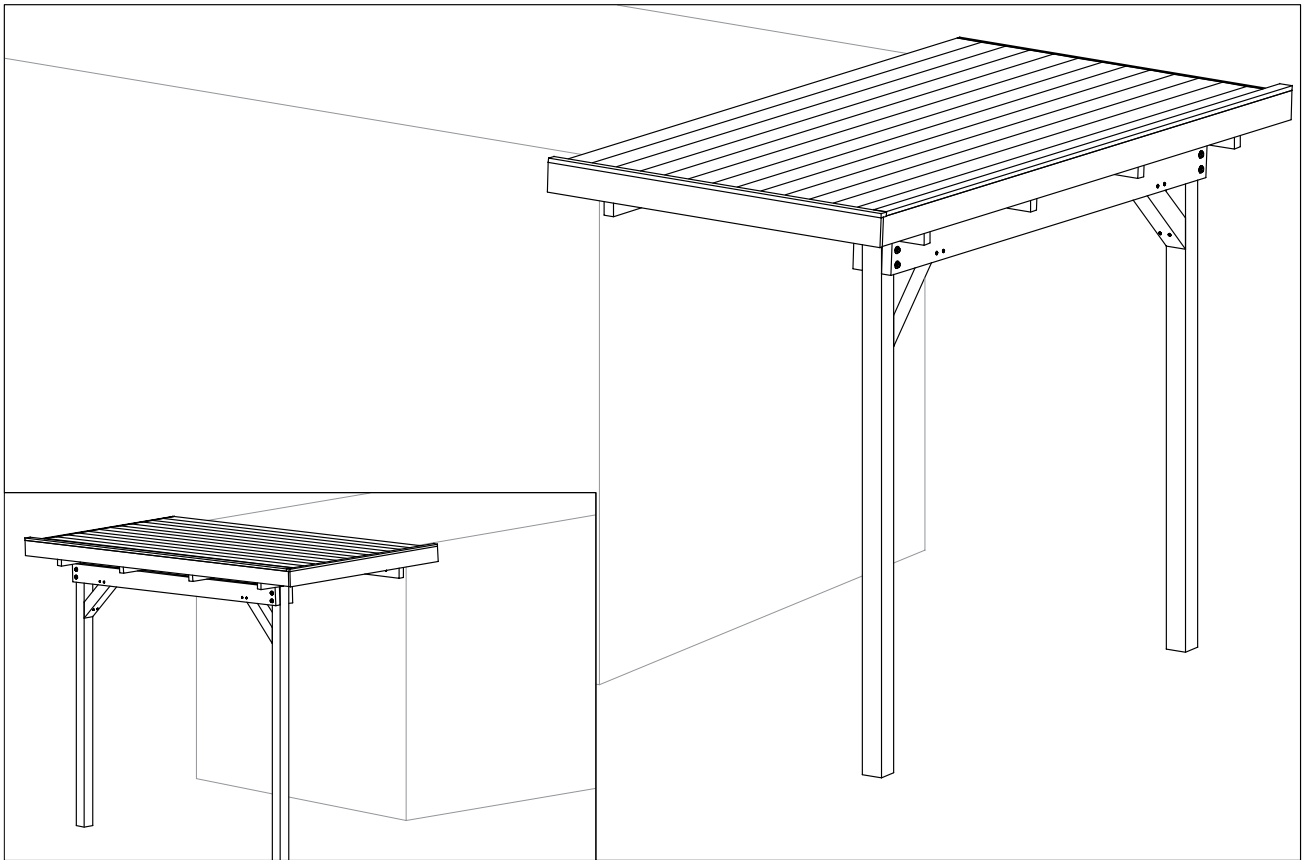





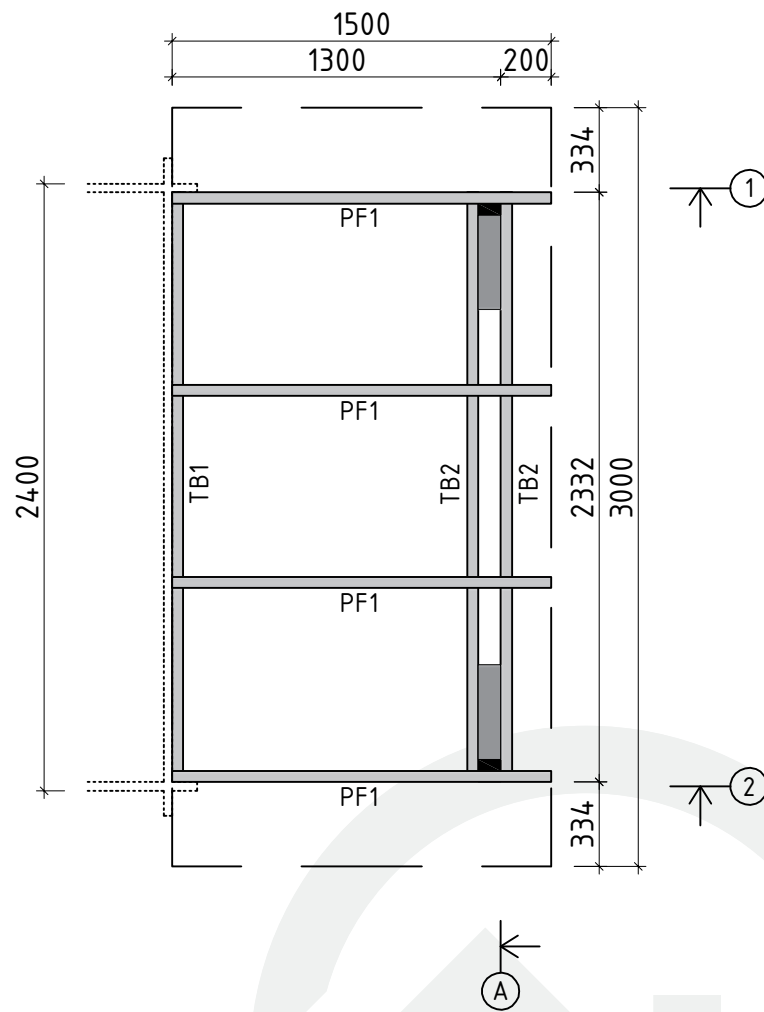





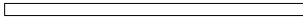

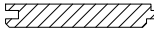
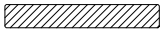



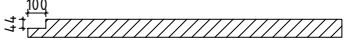

Grundriss

Art.-Nr. 700 200

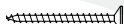
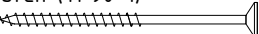

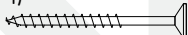
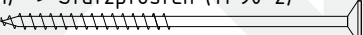
Teileliste 1

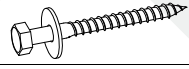
Art.-Nr. 700 200

Pos		Stck	Profil (mm)	Länge (mm)
TB2	TRÄGEBALKEN 	2	44x145	2330
TB1	TRÄGEBALKEN 	1	44x94	2330
PF1	PFETTEN 	4	44x145	1500
	DACHBRETTER 	14+1	113x18	3005
G02-1	GIEBELBRETTER 18x120 	1	18x120	3025
G05-1	GIEBELDECKLEISTEN 18x40 	1	18x40	3025
T02-1	TRAUFENBRETTER 18x120  ✓	1	18x120	1520
T01-1	TRAUFENBRETTER 18x90  ✓	1	18x90	1520
T04-1	TRAUFENDECKLEISTEN 18x40  ✓	1	18x40	1520
T06-1	TRAUFENLEISTEN 18x40  ✓	2	18x40	1520
TP90-1	STÜTZPFOSTEN 90x90 	2	90x90	550
TP90-2	STÜTZPFOSTEN 90x90  ✓	2	90x90	2310
W01	Winkel 40x40x40 	4		
NG01	DACHPAPPNÄGEL 2.8x15 	100		
NG04	NÄGEL 2.5x50 Dachbretter 	112		
SR32	SCHRAUBEN 3.0x30 Giebeldeckleisten Traufenleisten, Traufendeckleisten 	15		
SR37	SCHRAUBEN 3.5x45 Giebelbretter, Traufenbretter 	12		
SR57	SCHRAUBEN 5.0x100 Trägebalken (TB2) -> Stützpfofen (TP90-1) 	8		
SR51	SCHRAUBEN 5.0x30ÜP Winkel (W01) 	32		
SR55	SCHRAUBEN 5.0x70 Stützpfofen (TP90-2) -> Pfetten (PF1) 	4		
SR61	SCHRAUBEN 6.0x140 Stützpfofen (TP90-1) -> Stützpfofen (TP90-2) 	4		
SS32	Schloßschrauben M8x100 Mutter M8 U-Scheibe Ø25 	9	M8	
SS56	Sechskant Holzschrauben M10x100 U-Scheibe M10 Ø30 	8	M10	
KP-1	DACHPAPPE  ✓		1,8m-4st.	8,0 lfm
	✓ - bitte selber anpassen (falls nötig!)			

Wandplan 1 und 2

Art.-Nr. 700 200

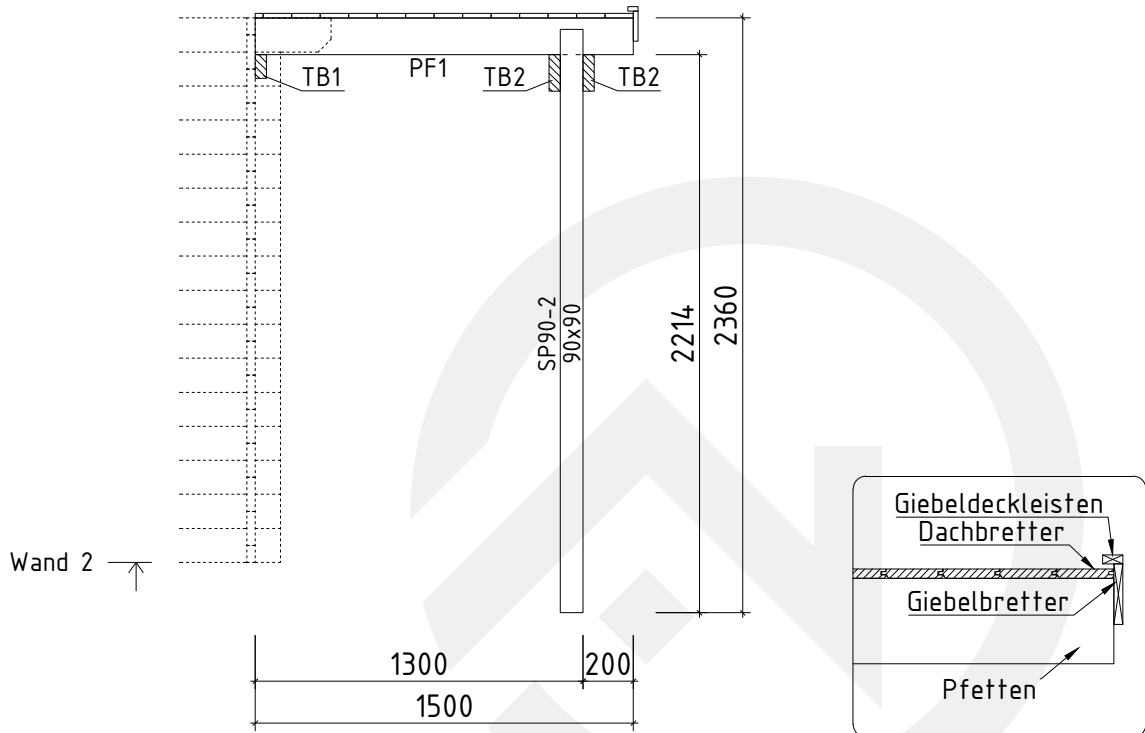
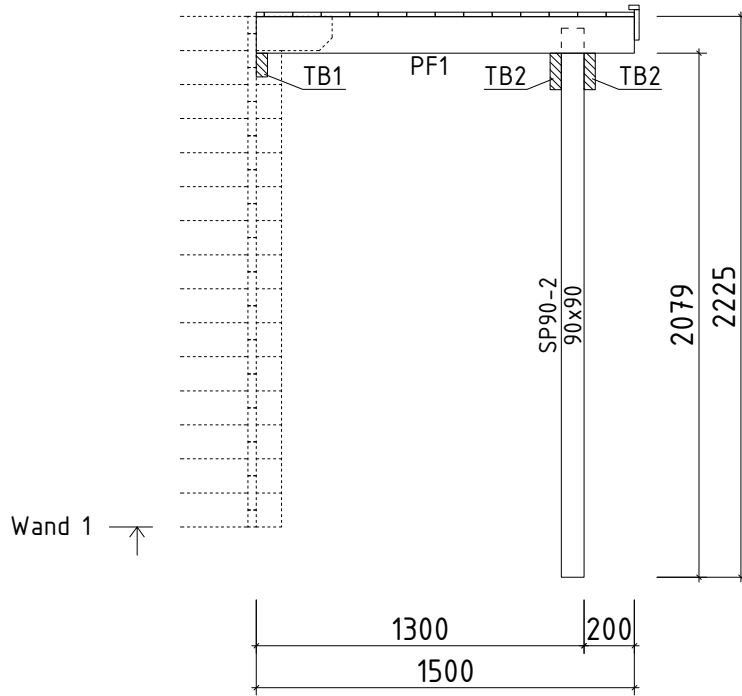

Wandplan A

Art.-Nr. 700 200

