













Mehr Produkte finden Sie  
in unserem Katalog!

Art.-Nr. 534 214



#### DIMENSIONEN

	Bohlenstärke	34 mm
	Innenmaß	293 x 233 cm
	Sockelmaß	430 x 240 cm
	Gesamtmaß	480 x 300 cm
	Grundfläche	10,3 m <sup>2</sup>
	Seitendach	150 cm
	Rauminhalt	20,8 m <sup>3</sup>
	Seitenwandhöhe v/h	217/205 cm
	Dachüberstand umlaufend	30 cm
	Dachneigung	4 °
	Dachfläche	14,4 m <sup>2</sup>
	Dachbretter inkl. Dachpappe	18 mm
	Fußboden	18 mm

#### TÜR

	Doppeltür (Dreiecksglas)	143 x 186 cm
--	-----------------------------	--------------

#### VERPACKUNG

	Paketmaß	
	Paket 1	407 x 117 x 60 cm
	Paket 2	200 x 100 x 20 cm
	Gesamtgewicht	865 kg

#### ZUBEHÖR

4 Rollen Dichtungsbahnen  
**Dachrinne**  
Kunststoff 404Ax anthrazit  
Alu bis 600 cm  
mit 1 Fallrohr

## Pulti 34-B Typ 4 mit SD A

34 mm | 430 x 240 cm | 10,3 m<sup>2</sup>

**5** JAHRE  
GARANTIE



Die UVP-Preise finden Sie in der Preisliste oder unter:  
[www.finnhaus.de/downloads.php](http://www.finnhaus.de/downloads.php)

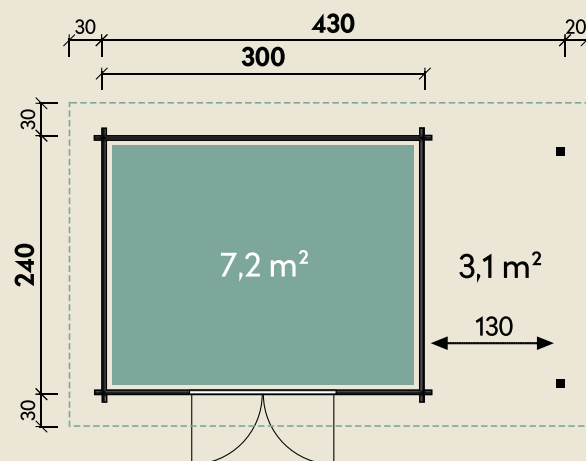

Alle Preise sind empfohlene Verkaufspreise inklusive der gesetzlichen MwSt.  
Weitere Informationen finden Sie unter: [www.finnhaus.de](http://www.finnhaus.de) oder im aktuellen Katalog.  
Technische Änderungen, Druckfehler und Irrtümer vorbehalten.