

AS Lasita Maja
Pihva küla
Risu tee 2
61407 Tähtvere vald
Tartumaa, Estonia
www.lasita.com

Art.No. 700902

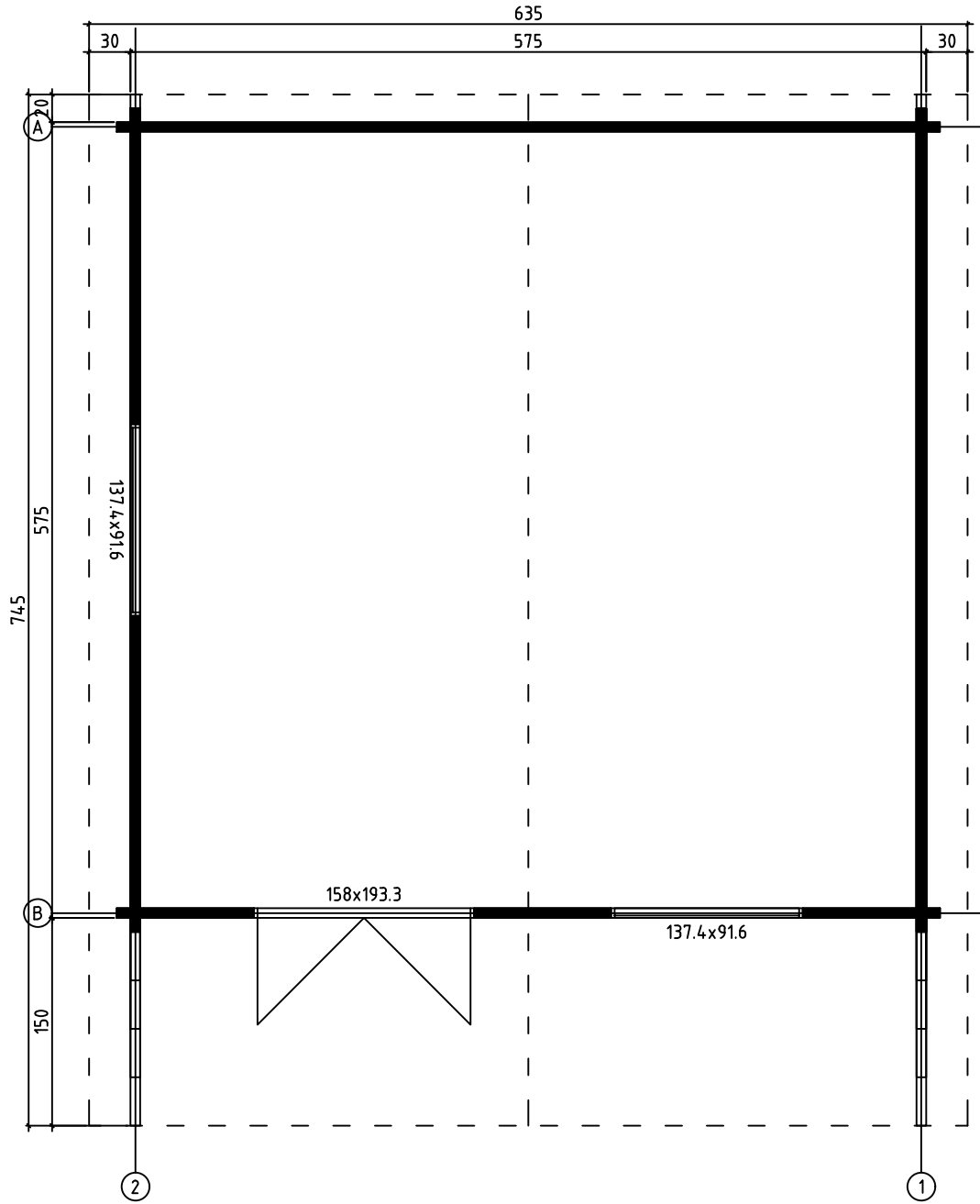

GROUNDPLAN - GRUNDPLAN - PLAN DE MASSE - PLANIMETRIA



FOUNDATION - FUNDAMENT - FONDAZIONE - FONDAMENTA

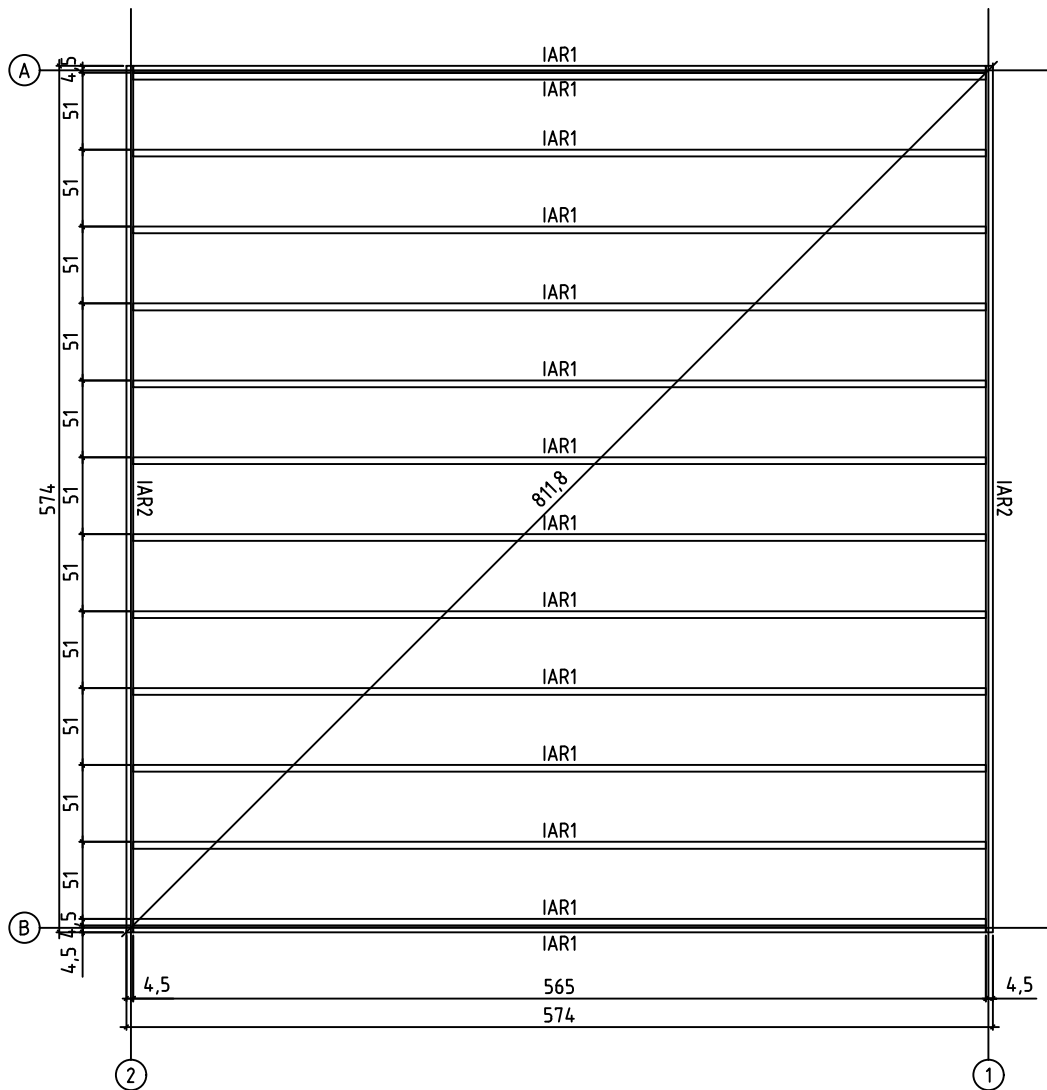



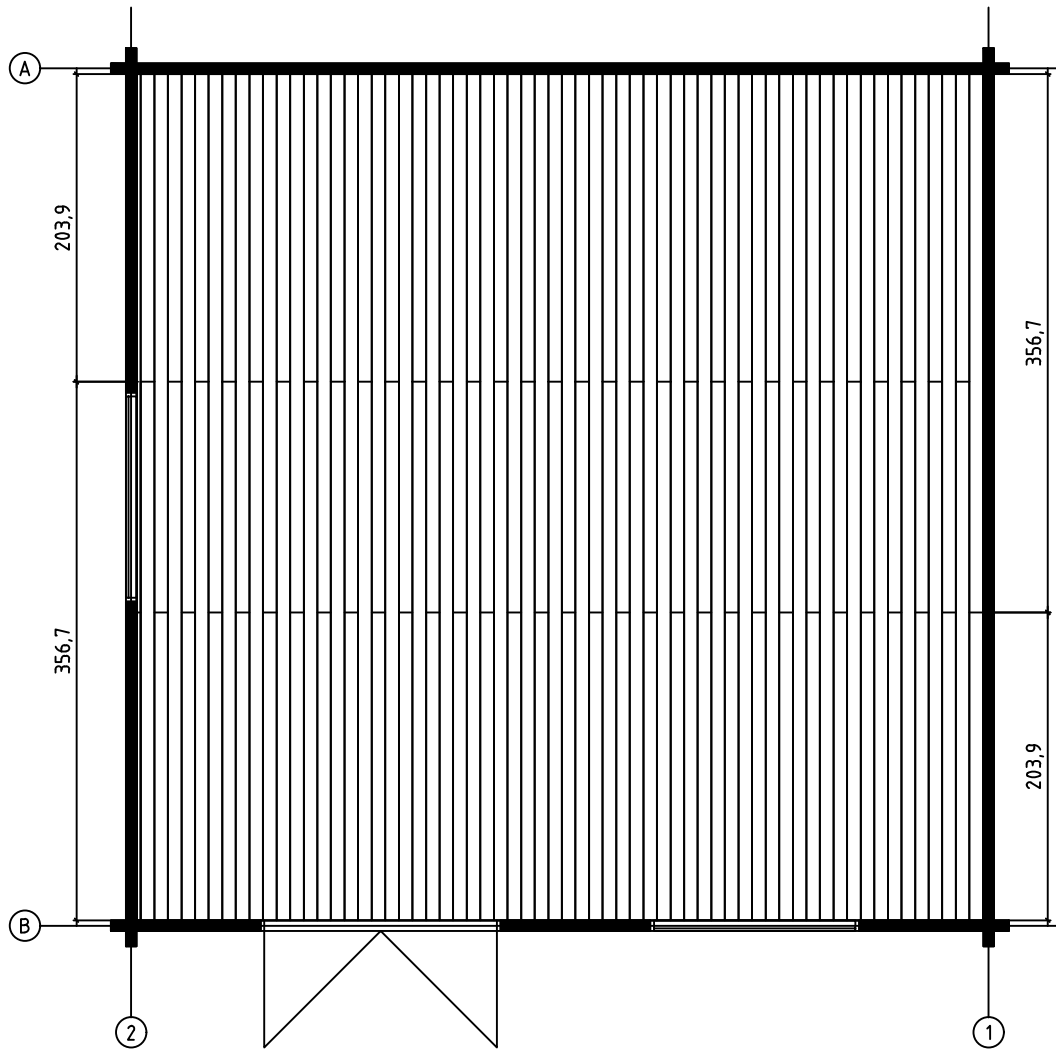

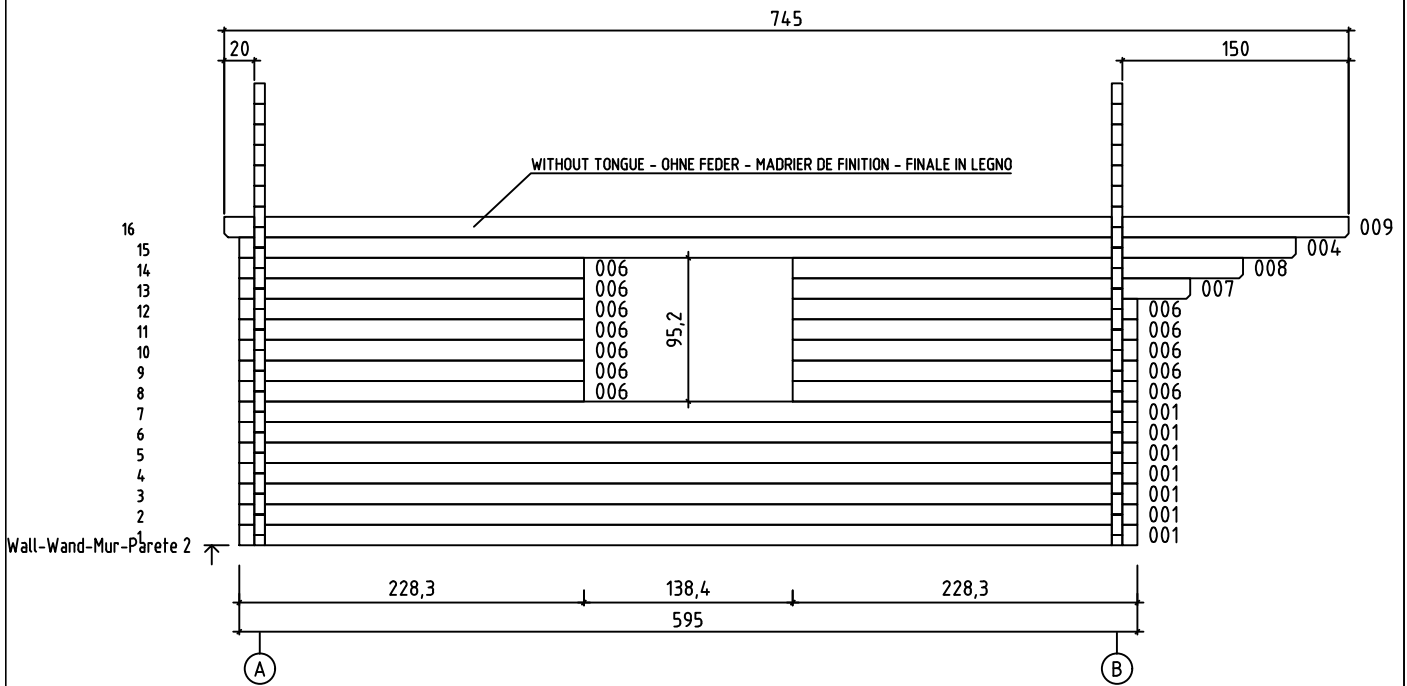
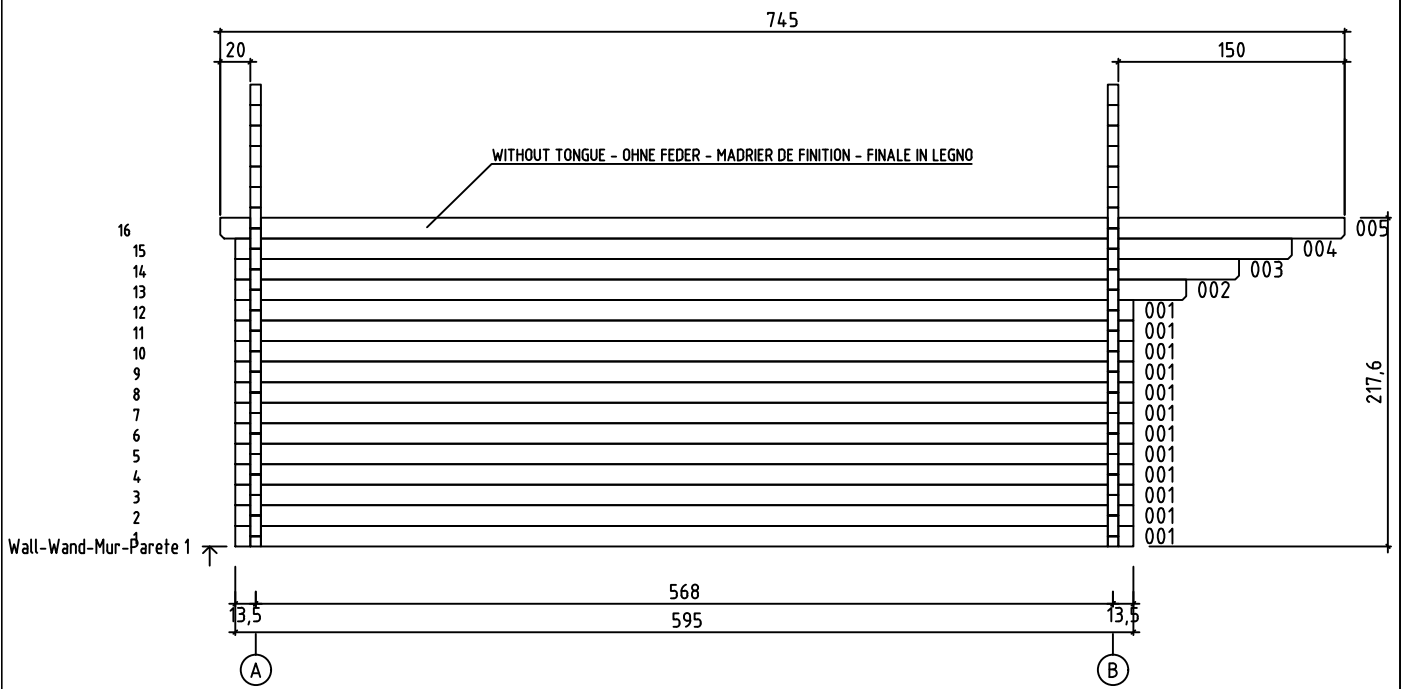
FLOOR BOARDS - FUSSBODENBRETTER - LAME DE PLANCHER - PAVIMENTO

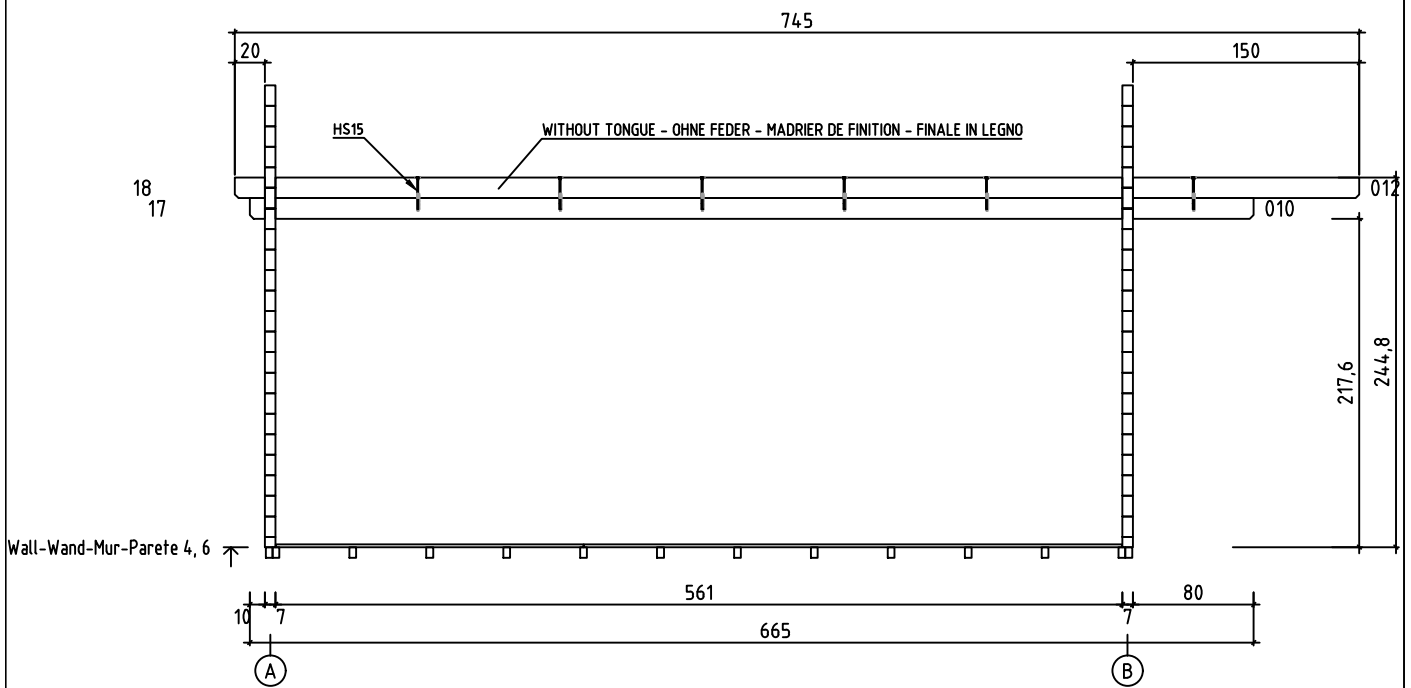
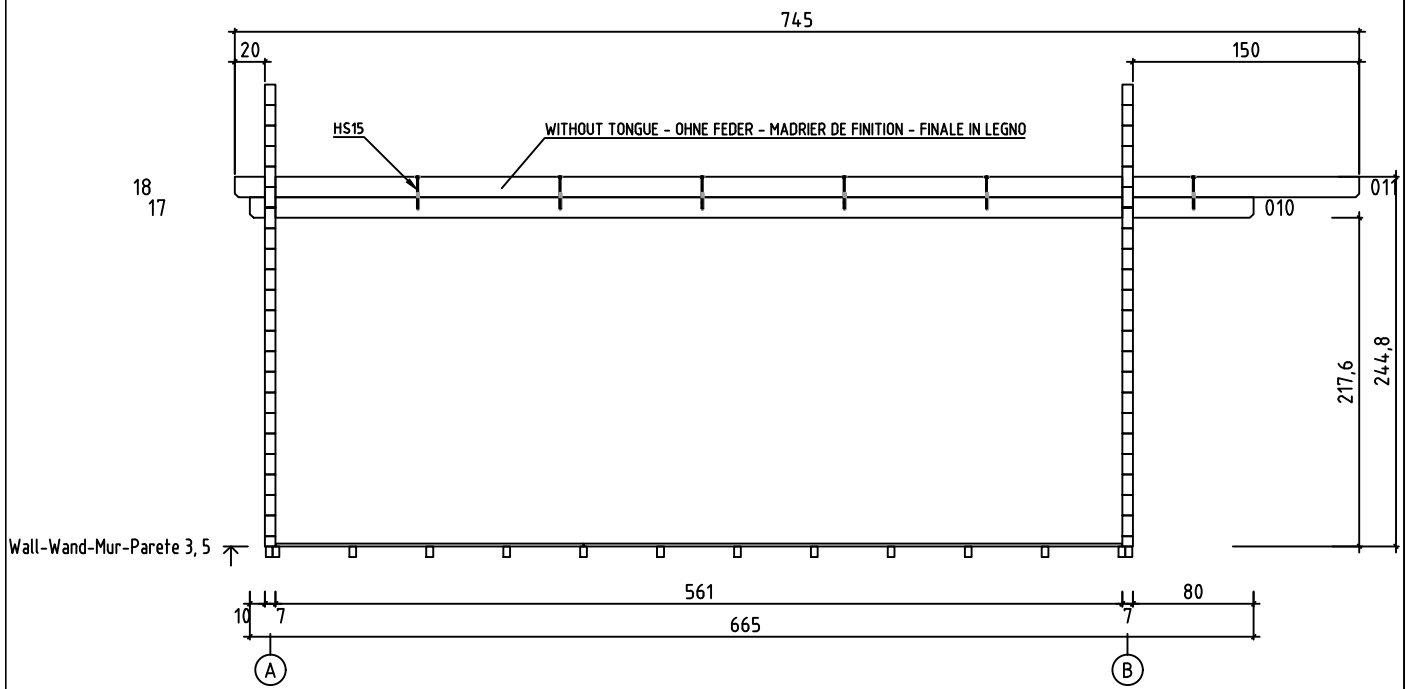

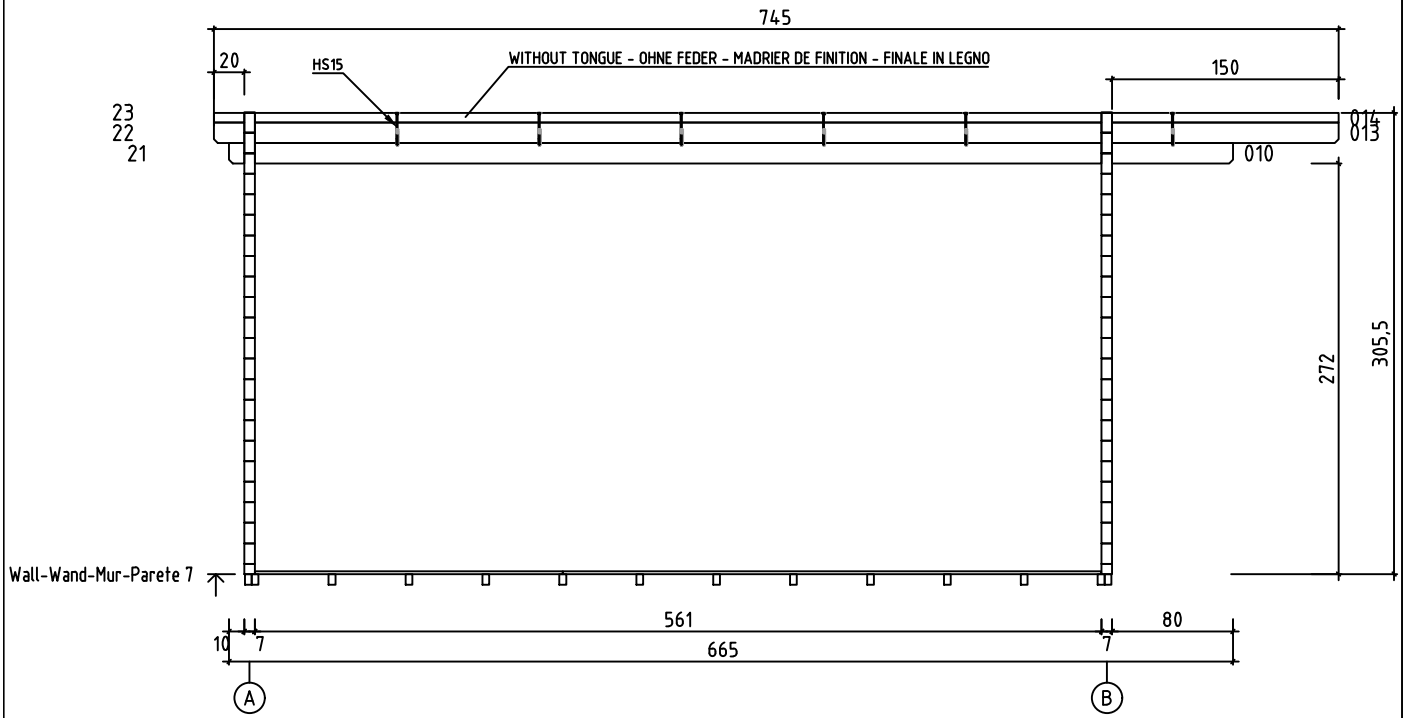

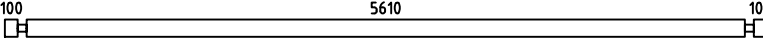
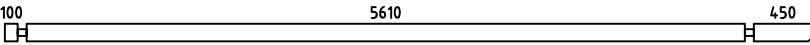
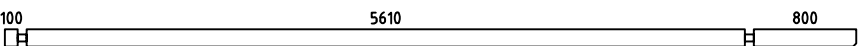
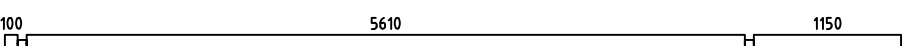

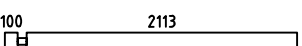
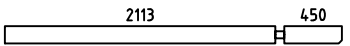
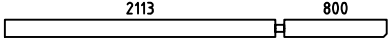
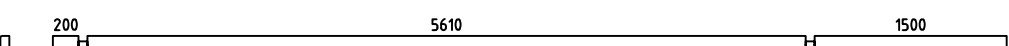
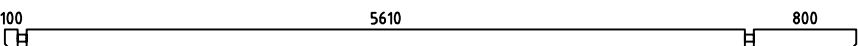
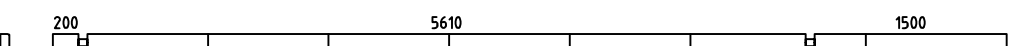
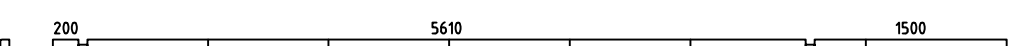
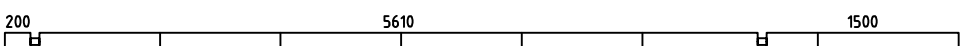

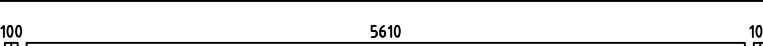
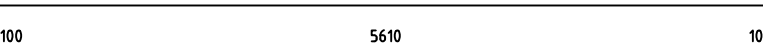
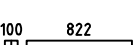
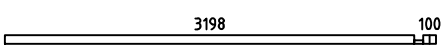
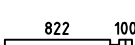
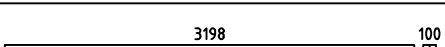
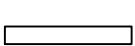
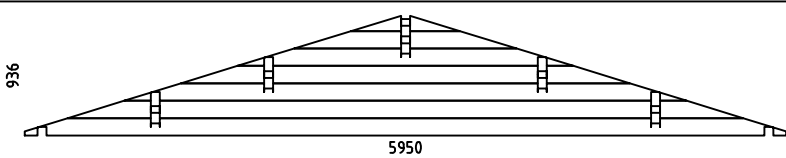
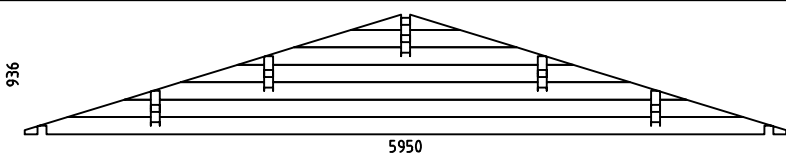

Pos	Art.No. 700902 Piece list - Stückliste - Liste des pièces - Elementi	St.	Profile (mm)	Lenght (mm)
001		19	70x136	5950
002		1	70x136	6300
003		1	70x136	6650
004		2	70x136	7000
005		1	70x136	7450
006		12	70x136	2283
007		1	70x136	2633
008		1	70x136	2983
009		1	70x136	7450
010		5	70x136	6650
011		2	70x136	7450
012		2	70x136	7450
013		1	70x136	7450
014		1	70x63	7450
015		1	70x68	5950
016		16	70x136	5950
024		1	70x68	992
025		1	70x68	3368
026		21	70x136	992
027		7	70x136	3368
028		7	70x136	992
WA-1		1		
WB-1		1		

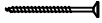
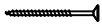
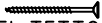
Pos	Art.No. 700902 Piecce list - Stückliste - Liste des pièces - Elementi	St.	Profile (mm)	Lenght (mm)
IAR2	FOUNDATION - FUNDAMENT - FONDATION - FONDAMENTA 	2	45x70	5740
IAR1	FOUNDATION - FUNDAMENT - FONDATION - FONDAMENTA 	14	45x70	5650
	FLOOR BOARDS - FUSSBODENBRETTER - LAME DE PLANCHER - PAVIMENTO 	63	90x18	3567
	FLOOR BOARDS - FUSSBODENBRETTER - LAME DE PLANCHER - PAVIMENTO 	63	90x18	2039
	ROOF BOARDS - DACHBRETTER - VOLIGES - PERLINA PER TETTO 	166	90x18	3300
FL	FLOOR FILLET - FUSSBODENLEISTE - CORNIERE DE FINITION DU PLANCHER - FINITURA PER PAVIMENTO (BATTISCO PA) 		18x18	22.42
DPL	ROOFING FELT FILLET - DACHPAPPENLEISTE - BAGUETTE DE FIXATION DU FEUTRE BITUMEUX - FINITURA PER TETTO PER CARTA BITUMINOSA 	4	18x58	3350
M12	TREADED ROD M12 - GEWINDESTANGE M12 - TIGE FILETÉE M12 - BARRA FILETTATA PASSO M12 	4		186
M12	TREADED ROD M12 - GEWINDESTANGE M12 - TIGE FILETÉE M12 - BARRA FILETTATA PASSO M12 	4		2000
TB	FASCIA BOARD - TRAUFBRETT - BANDEAU DE TOIT - FINITURA LATI TETTO 	4	18x90	3725
DRV	ROOF EDGE REINFORCEMENT - DACHRANDVERSTÄRKUNG - CORNIERE DE RENFORT DE BORD DE TOIT - RINFORZO x TETTO 	4	28x34	3725
GL	GABLE MOULDING - GIEBELLEISTE - PLANCHE DE RIVE - FINITURA PER FRONTALE E RETRO DEL TETTO 	4	18x120	3350
GS	GABLE SEGMENT - DECKBLATT - LOSANGE DE FINITION - DECORAZIONE IN LEGNO x FRONTALE TETTO 	2		
KL4	LENGTHENING BOLT FOR TREADED ROD - VERLÄNGERUNGSMUTTER FÜR GEWINDESTANGE - MANCHON DE RACCORDEMENT DE TIGE FILETÉE - BULLONE PER BARRA FILETTATA PASSO 	4		
KL1	DRIVE NUT TREADED ROD - EINSHLAGMUTTER FÜR GEWINDESTANGE - ÉCROU A FRAPPER POUR TIGE FILETÉE - DADO GUIDA PER BARRA FILETTATA 	4		
KL2	NUT FOR TREADED ROD - MUTTER FÜR GEWINDESTANGE - ÉCROU POUR TIGE FILETÉE - DADO PER BARRA FILETTATA 	4		
KL3	PLAIN WASHER TREADED ROD - UNTERLEGSCHIEBE FÜR GEWINDESTANGE - RONDELLE PLATE POUR TIGE FILETÉE - RONDELLA PER BARRA FILETTATA 	4		
HS12	SCREW FOR GABLE SEGMENT - SCHRAUBEN FÜR DECKBLATT - VIS POUR FIXATION LOSANGE DE FINITION - VITI x FRONTALI TETTO 	4	3.5x35	
HS18	SCREW FOR ROOF BOARDS - SCHRAUBEN FÜR DACHBRETTER VIS D'ASSEMBLAGE DES VOLIGES DE TOIT - VITI PER LE PERLINE DEL TETTO 	685	3.5x50	
HS17	SCREW FOR FLOOR BOARDS - SCHRAUBEN FÜR FUSSBODENBRETTER VIS D'ASSEMBLAGE DES LAMES DE PLANCHER - VITI PER LE PERLINE DEL PAVIMENTO 	832	3.5x50	
HS16	SCREW FOR GABLE MOULDING - SCHRAUBEN FÜR GIEBELLEISTE - VIS POUR FIXATION PLANCHE DE RIVE - VITE PER FISSARE FINITURE DAVANTI E DIETRO DEL TETTO 	32	3.5x50	
HS32	SCREW FOR FASCIA BOARDS - SCHRAUBEN FÜR TRAUFBRETTER - VIS POUR FIXATION BANDEAU DE TOIT - VITI x STRISCIA DEL TETTO 	36	4x40	
HS26	SCREW FOR ROOF EDGE REINFORCEMENT - SCHRAUBEN FÜR DACHRANDVERSTÄRKUNG - VIS POUR FIXATION CORNIERE RENFORT DE BORD DE TOIT - VITI x RINFORZO BORDO TETTO 	36	4x40	
HS43	SCREW FOR ROOF BEAMS - SCHRAUBEN FÜR DACHBALKEN - VIS POUR FIXATION PANNES DE TOIT - VITI PER PERLINE DEL TETTO 	14	5x120	
HS42	SCREW FOR GABLE - SCHRAUBEN FÜR GIEBEL - VIS POUR FIXATION DES PIGNONS - VITI PER TIMPANO 	28	5x120	

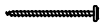
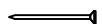
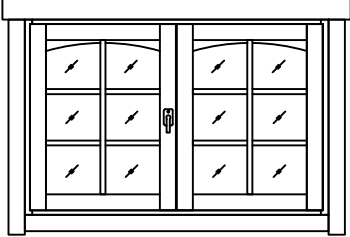
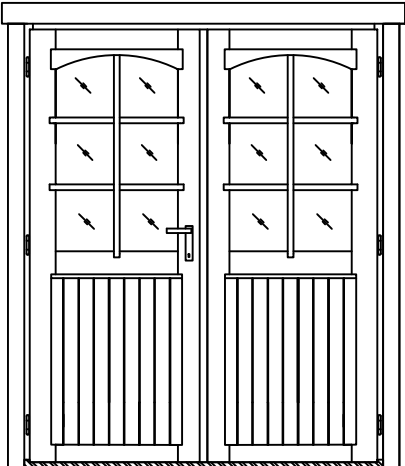
Pos	Art.No. 700902 Piece list - Stückliste - Liste des pièces - Elementi	St.	Profile (mm)	Lenght (mm)
HS40	SCREW FOR 1. WALL BEAM - SCHRAUBE FÜR 1. BOHLENREIHE - VIS DE FIXATIONS 1 ^{ere} RANGÉE DE MADRIERS AVEC POUTRELLES DE FONDATIONS - VITE FISSAGGIO ALLE FONDAMENTA 	10	5x120	
HS39	SCREW FOR FOUNDATION - SCHRAUBEN ZUR BEFESTIGUNG FUNDAMENT - VIS DE FIXATIONS DES POUTRELLES DE FONDATIONS - VITI x FONDAMENTA 	36	5x90	
HS15	SCREW FOR FIXING ROOF BEAMS - VERBINDUNGSSCHRAUBEN FÜR DACHPFETTEN - VIS DE FIXATION DES PANNES DE TOIT - VITI PER IL FISSAGGIO DELLE TRAVI DEL TETTO 	30	8x220	
NFF	ZN NAIL FOR FLOOR FILLET - ZN NÄGEL FÜR FUSSBODENLEISTE - POINTE POUR CORNIERE DE FINITION DU PLANCHER - CHIODI x FISSAGGIO PAVIMENTO 	46	1.4x40	
SH70	HAMMER BLOCK - SCHLAGHOLZ - CALLE DE FRAPPE - BLOCCO DI LEGNO DA USARE COME CUSCINETTO QUANDO SI USA IL MARTELLO 	1		
MS	SCREW FOR DOORSTEP - SCHRAUBEN FÜR SWELLE - VIS POUR FIXATION BARRE DE SEUIL - VITE PER SOGLIA DELLA PORTA 	3	4.5x65	
NFD	ZN NAIL FOR ROOFING FELT FILLET - ZN NÄGEL FÜR DACHPAPPENLEISTE - POINTE POUR BAGUETTE DE FIXATION FEUTRE BITUMEUX - CHIODI x CARTA BITUMINOSA x TETTO 	32	2x40	
ORZ	MONTAGE SET FOR DOORS AND WINDOWS - MONTAGE-SET FÜR TUREN UND FENSTER - JEU DE MONTAGE PORTES ET FENETRES - SET DI ASSEMBLAGGIO PER PORTE E FINESTRE	1		
3+ TA .6V.K	WINDOW - FENSTER - FENETRE - FINESTRA 1374x916 	2		
2+ TU .26V.K	DOOR-TÜR-PORTE-PORTE 1580x1933 	1		

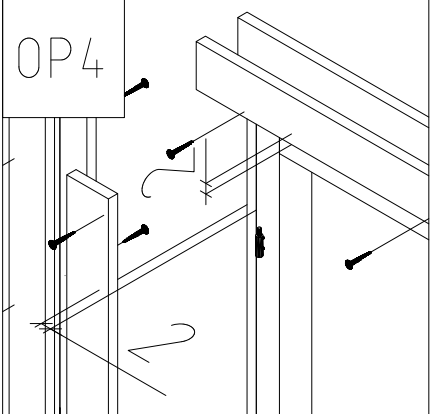
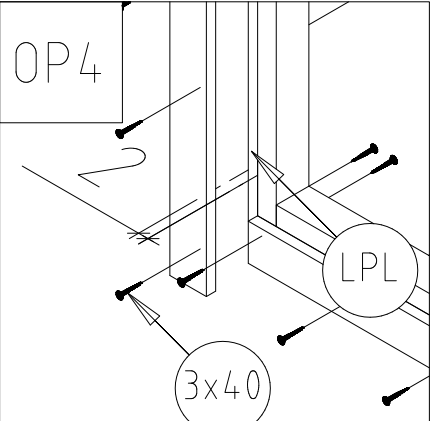
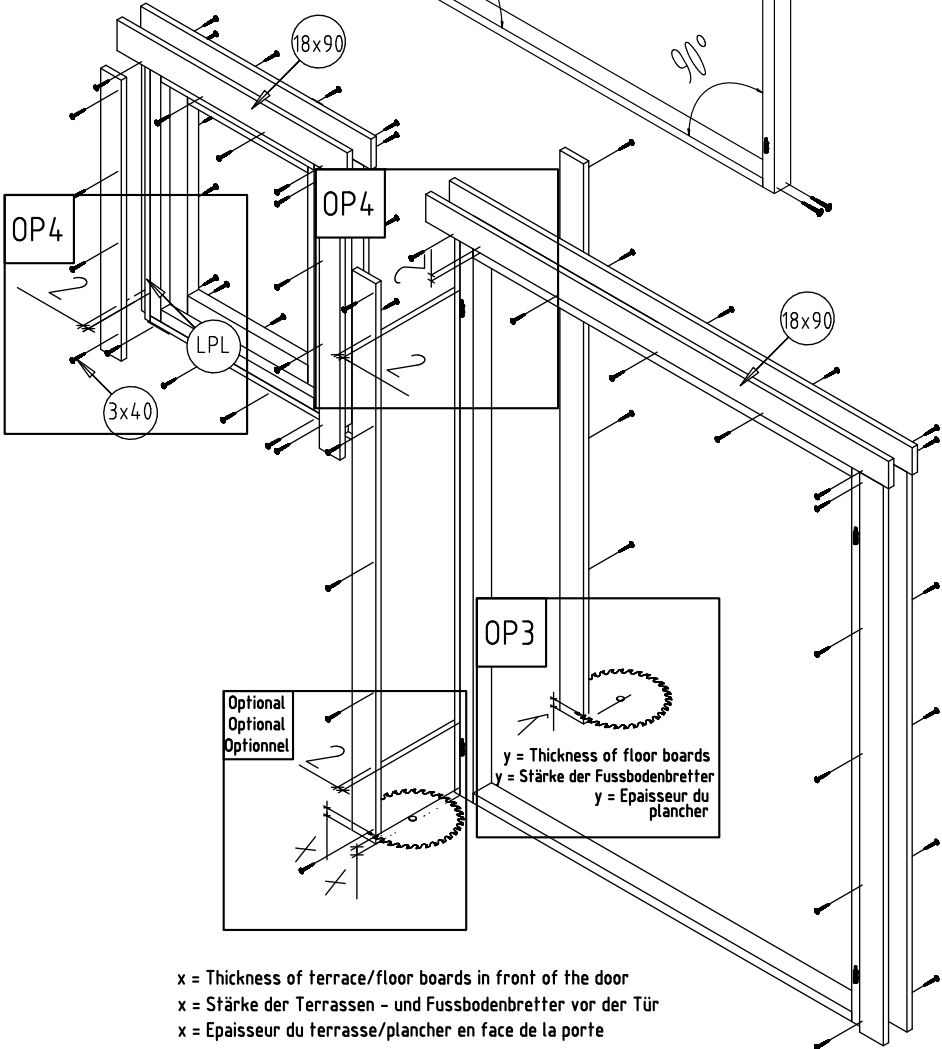
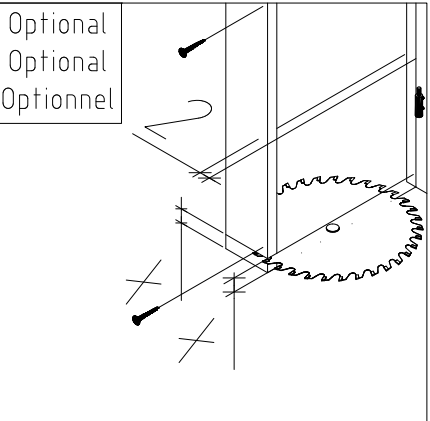
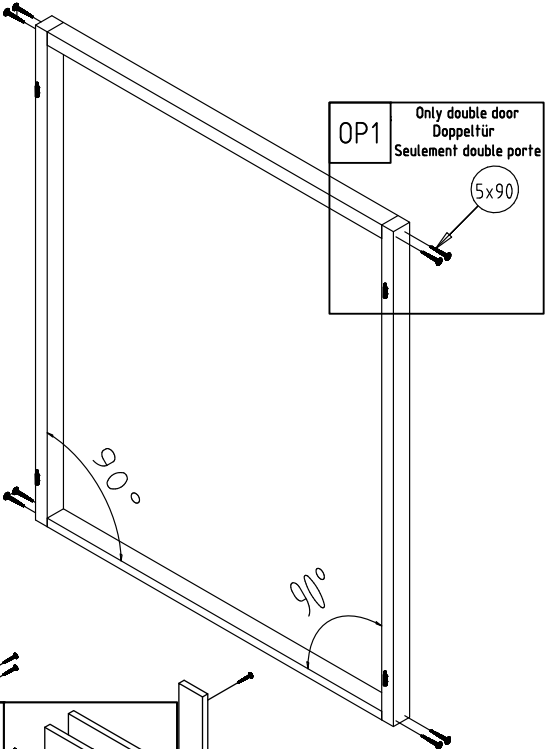
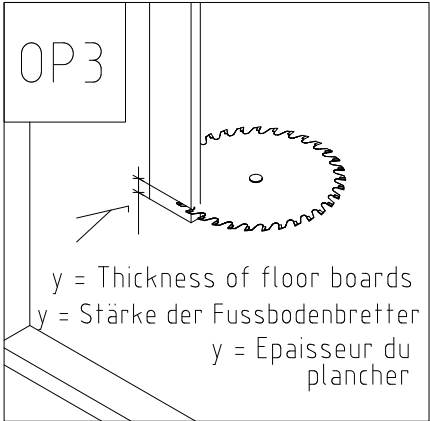
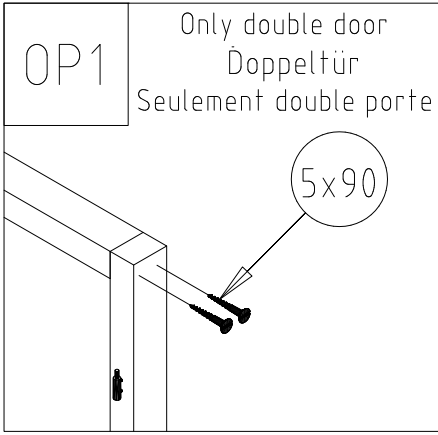

x = Thickness of terrace/floor boards in front of the door
x = Stärke der Terrassen - und Fussbodenbretter vor der Tür
x = Epaisseur du terrasse/plancher en face de la porte

