

Technische Daten: Art.-Nr.: 870815

Wandaußenmaß: 360 x 360 cm

Bohlenstärke: 70 mm



Trondheim 70-D XL

Kontrolliert durch:

Empty box for signature or name.

Achtung: Alle angegebenen Maße sind ca.-Maße!

3D-Darstellung und Grundriss 870815

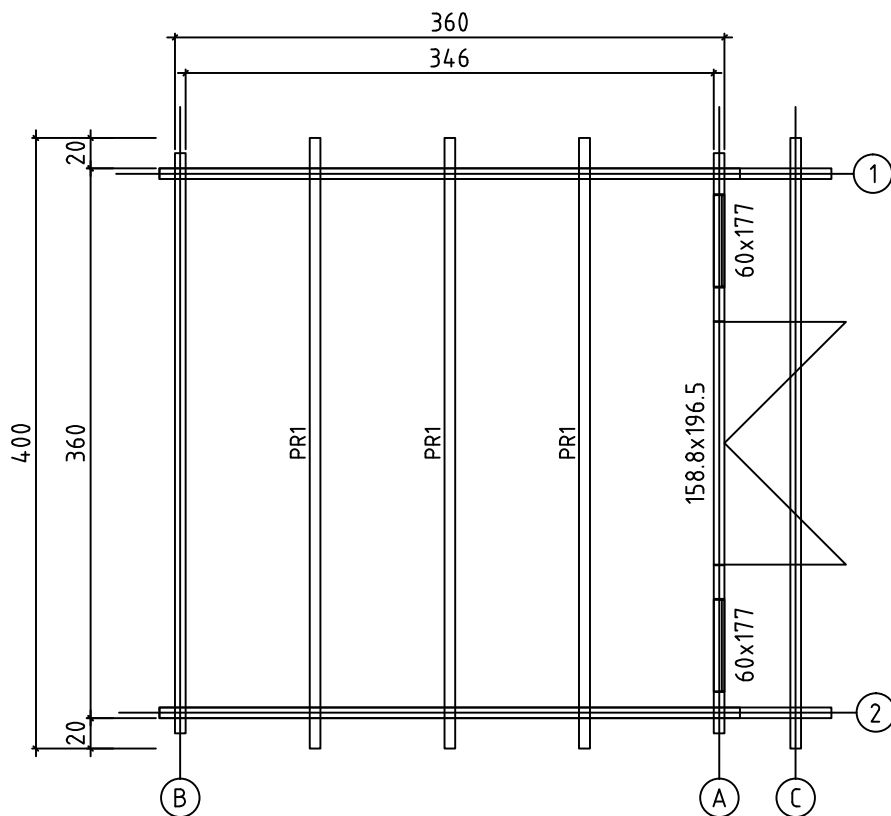
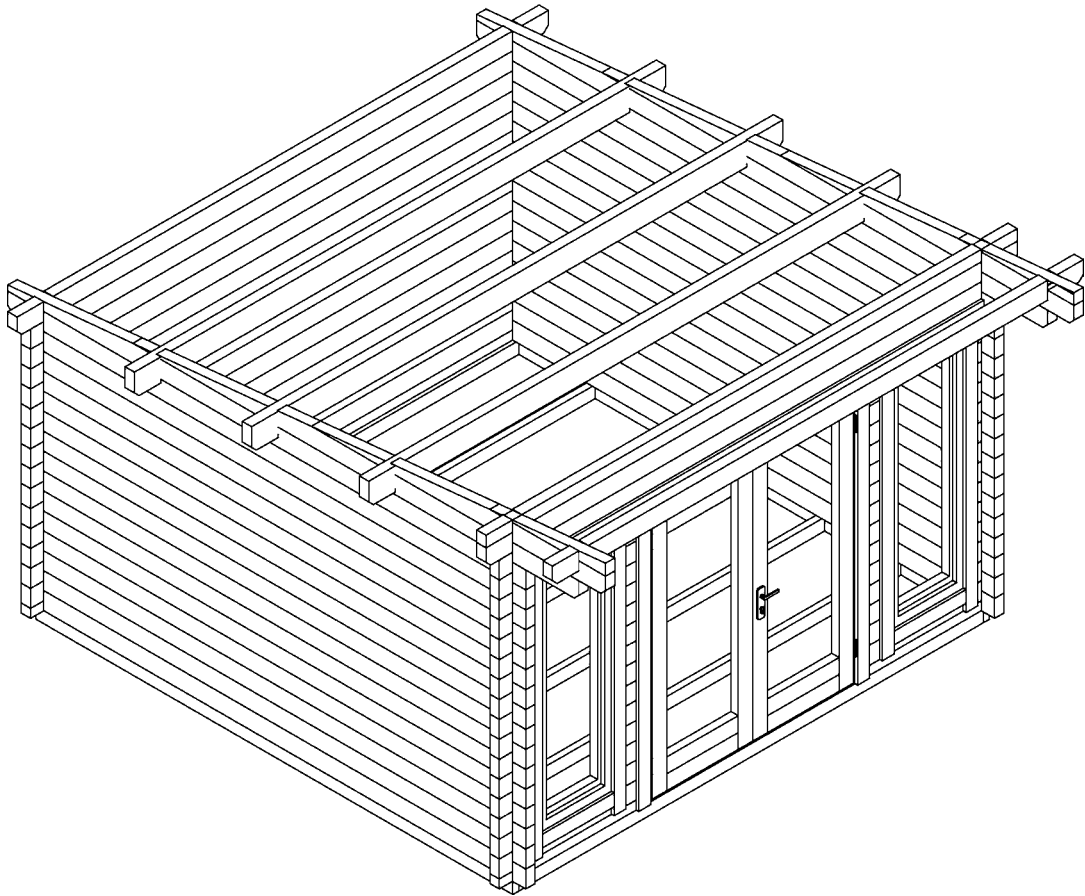





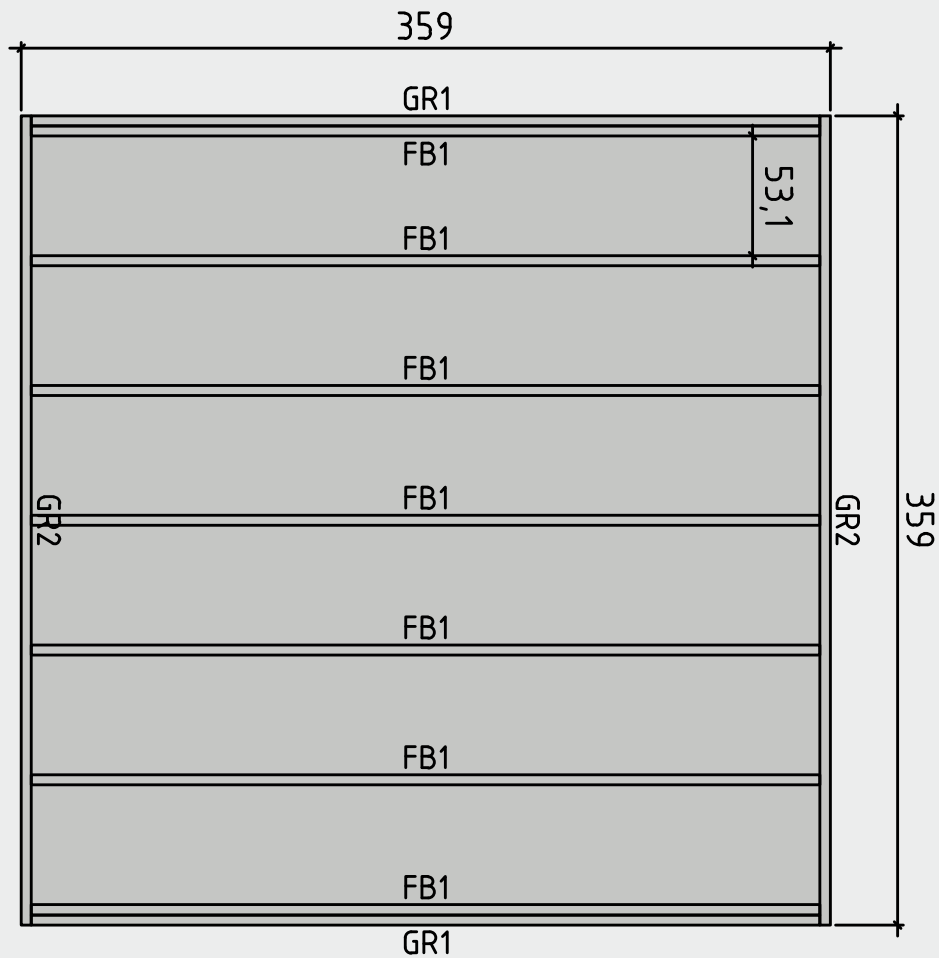

Lagerholzplan und Fundamentplan 870815

Wir empfehlen als Fundament für Ihr Gartenhaus eine vollflächig festgegründete, gepflasterte oder betonierte Fläche.
Wahlweise ist auch ein Punkt- oder Streifenfundament möglich.

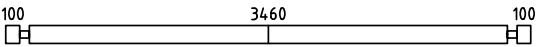
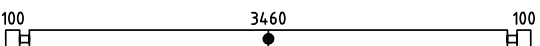
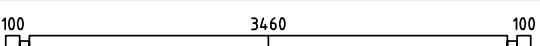
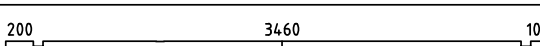
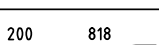
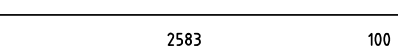

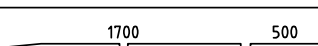

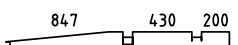
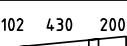
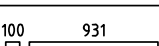
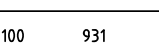

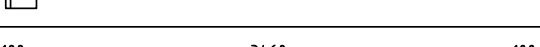
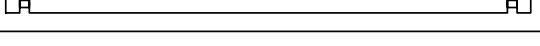
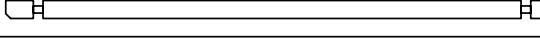
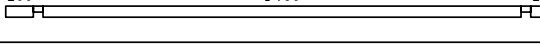
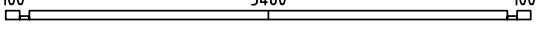
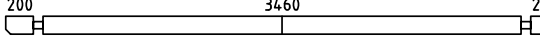
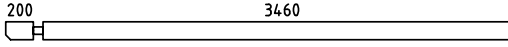
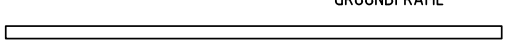
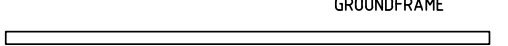



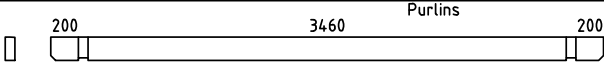
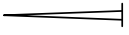

Teileliste 1

870815

Pos			Profil (mm)	Lenght (mm)
001		2	70x130	3800
002		3	70x130	3800
003		37	70x130	3800
004		2	70x130	3900
005		2	70x130	1088
006		2	70x130	2753
007	—	2	70x14	146
008		2	70x100	852
009		2	70x130	2270
010		2	70x55	567
011		2	70x130	1617
012		2	70x84	872
013		2	70x65	1101
014		2	70x130	1101
015		28	70x130	270
016		28	70x130	221
017		1	70x130	3800
018		1	70x130	4000
019		1	70x82	4000
020		1	70x65	3800
021		1	70x130	4000
022		1	70x130	4000
GR2	GROUNDFRAME 	2	45x90	3590
GR1	GROUNDFRAME 	2	45x90	3500
FB1	FLOORBEAMS 	7	45x90	3500

Teileliste 2

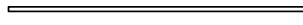
870815

Pos			Profil (mm)	Lenght (mm)
PR1			70x170	4000
	WINDOW 600x1770			
	DOOR 1588x1965			
1	Screws/Schrauben/Vis 5x100 mm- For fixing first row of wall logs /Fixierung des ersten Bohlenkranzes/Pour fixer les lamesde plancher 			6
2	Nails/Nägel/Clous 2.5x50 - For fixing floorboards/ Befestigung Fussbodenbretter/Pour fixer les lames de plancher 			275
3	Nails/Nägel/Clous 2.5x50 - For fixing roofboards/ Befestigung Dachbretter/Pour fixer les voliges 			275
4	Nails/Nägel/Clous 2.5x50 - For fixing floor edge trims/ Befestigung Fussleisten/Pour fixer les plinthes du plancher 			30
5	Nails/Nägel/Clous 2.5x50 - For fixing roofing felt fillet/ Befestigung giebelabschlussbrett/Pour fixer la latte de finition de la couverture 			20
6	Screws/Schrauben/Vis 2,5x50 mm- For fixing roof side boards and roof edge reinforcement Befestigung Traufenbretter und Traufenleisten Pour fixer les planches de rive et le tasseau de refront 			125
7	Screws/Schrauben/Vis 2,5x50 mm- For fixing fascia boards and diamonds/ Befestigung Giebelblende und Raute Pour fixer les planches de rive et le diamant 			
8	Screws/Schrauben/Vis 2,5x50 mm- For fixing fwindow and door trims/ Befestigung Fenster und türen/ Pour fixer les croissilons des fenetres et des portes 			
9	Metal storm Brace/Gewindestange/Tige filetee 10 mm 			3
10	Shim;Nuts/Mutter ,U-Scheibe/Ecrou;Rondelle 10 mm For fixing storm braces/ Pour fixer les anti tempete/ Für Sturmleisten Pour fixer les croissilons des fenetres et des portes  Metal storm Brace/Gewindestange/Tige filetee 10 mm KL1 M10 2,11 m 1 Screws 180 6 pcs. KL2 M10 2,18 m 2 Plastic caps 3 pcs.			3/3

Teileliste 3

870815

POS	ST.	B	H	L	Teileliste
FB1	Vt. spetsi				FUNDMENTHOLZER
F1	12m ²	28		3455	FUSSBODENBRETTER
PR	3	70	170	4000	DACHBALKEN
RB1	18,1m ²	20		4521	DACHBRETTER
R1	2	20	140	4040	<small>Vezte ketise kalcentrke</small> Traufenbretter
R2	2	45	65	4000	<small>Vezte ketise kalcentrke</small> Traufenbretter
R3	2	20	140	4720	<small>Vezte ketise kalcentrke</small> Giebelabschlussleiste
R4	2	20	90	4720	Giebelabschlussleiste
WN06	2	600	1770		<p style="text-align: center;">Sliding slats 30x30x1700 mm - 4 pcs.</p>
DR16	1	1588	1965		
P1	15m	20	40		Fußbodenleiste
P2	6+6	20	90	1945	Türleiste DR 16, Fensterleiste WN 06
P3	1+1	20	90	3440	Türleiste DR 16, Fensterleiste WN 06
P4	2+2	20	90	540 570	Fensterleiste WN 06

Detailzeichnungen 870815

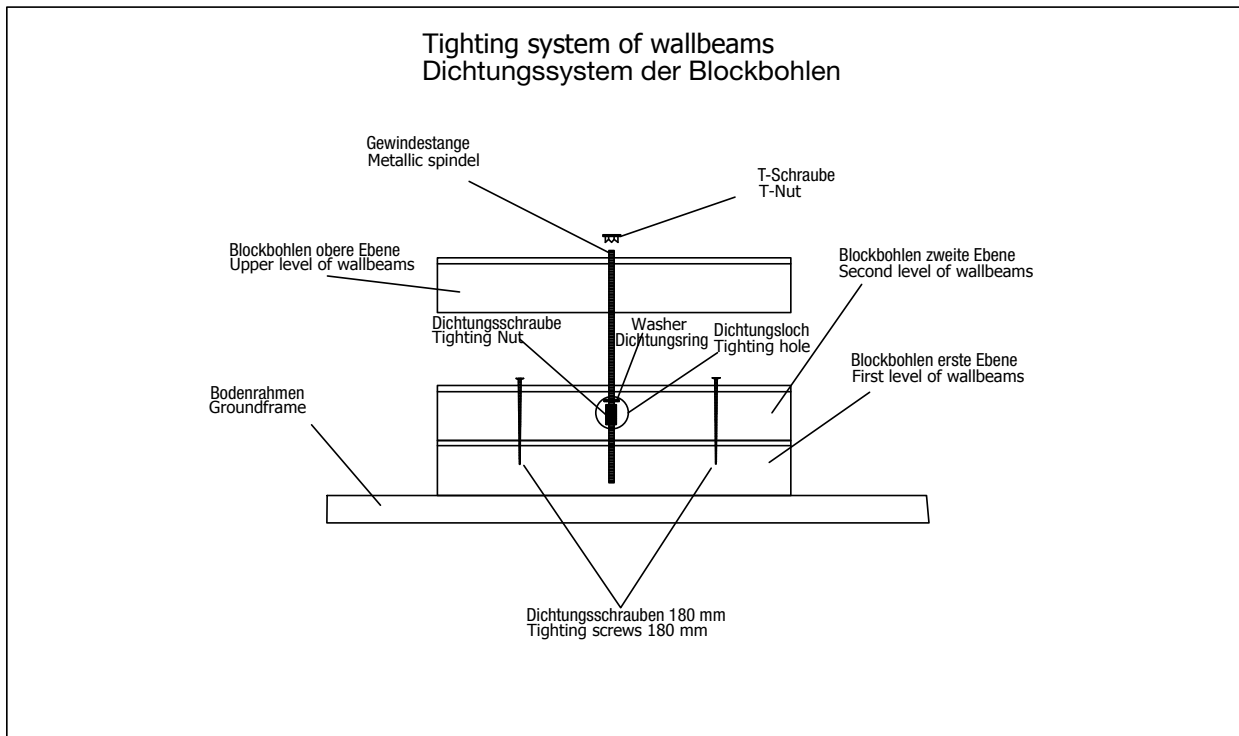
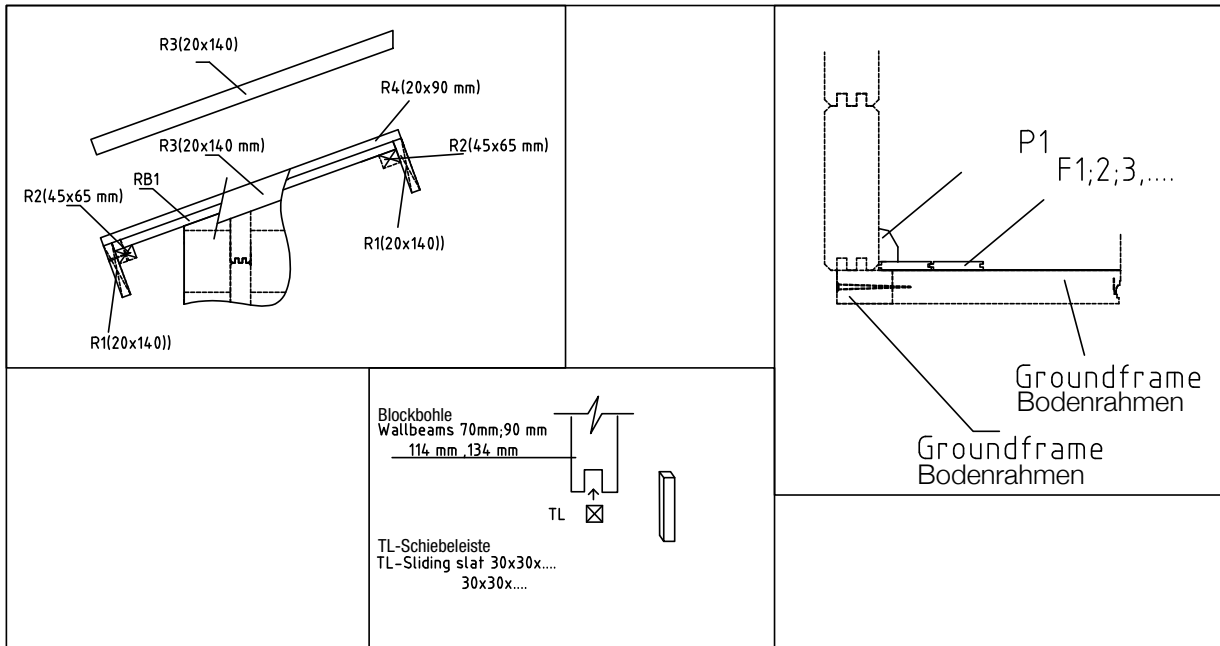

Wandplan A und B 870815

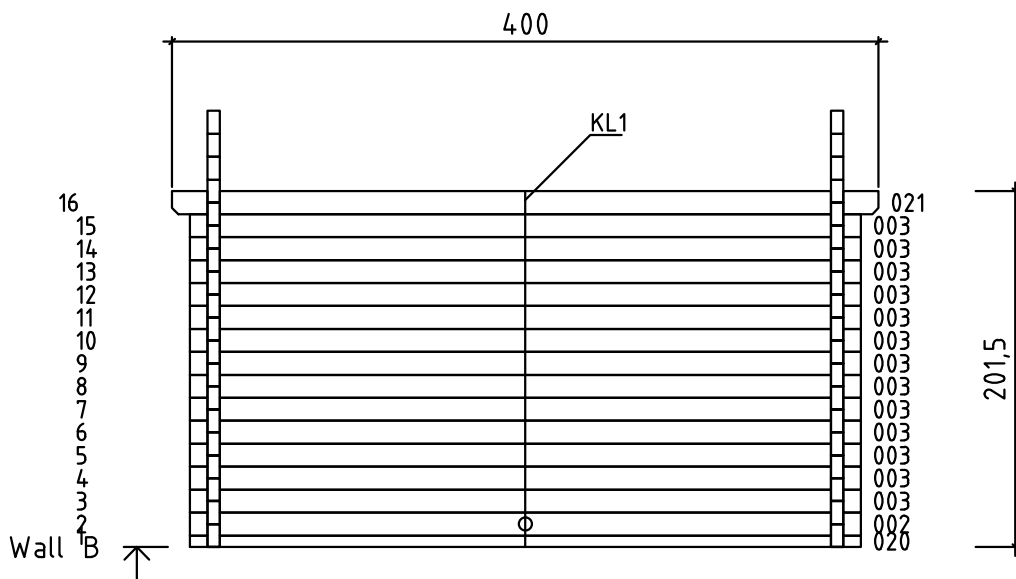
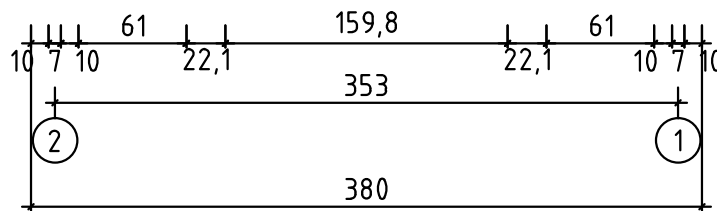
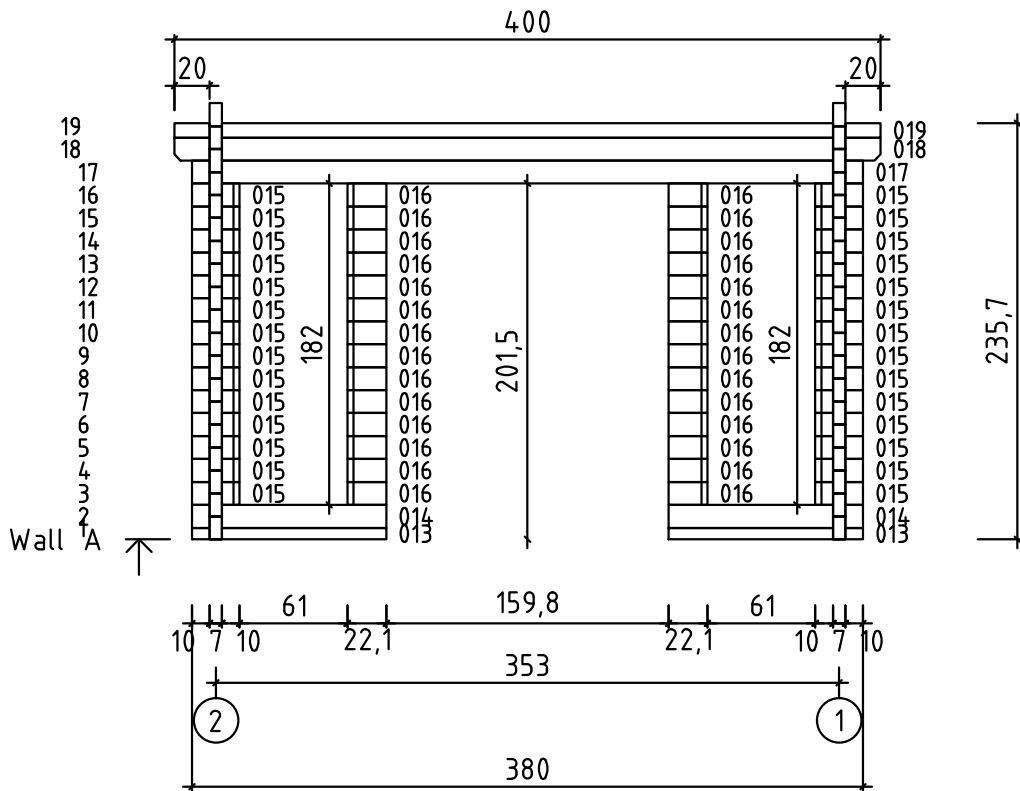

Wandplan C 870815

Vorgelagerte Vordachbohle vor Wand A

