

Technische Daten: Art.-Nr.: 350195

Wandaußenmaß: 395 x 366 cm

Bohlenstärke: 70 mm



Kontrolliert durch:

Achtung: Alle angegebenen Maße sind ca.-Maße!

3D-Darstellung 350195

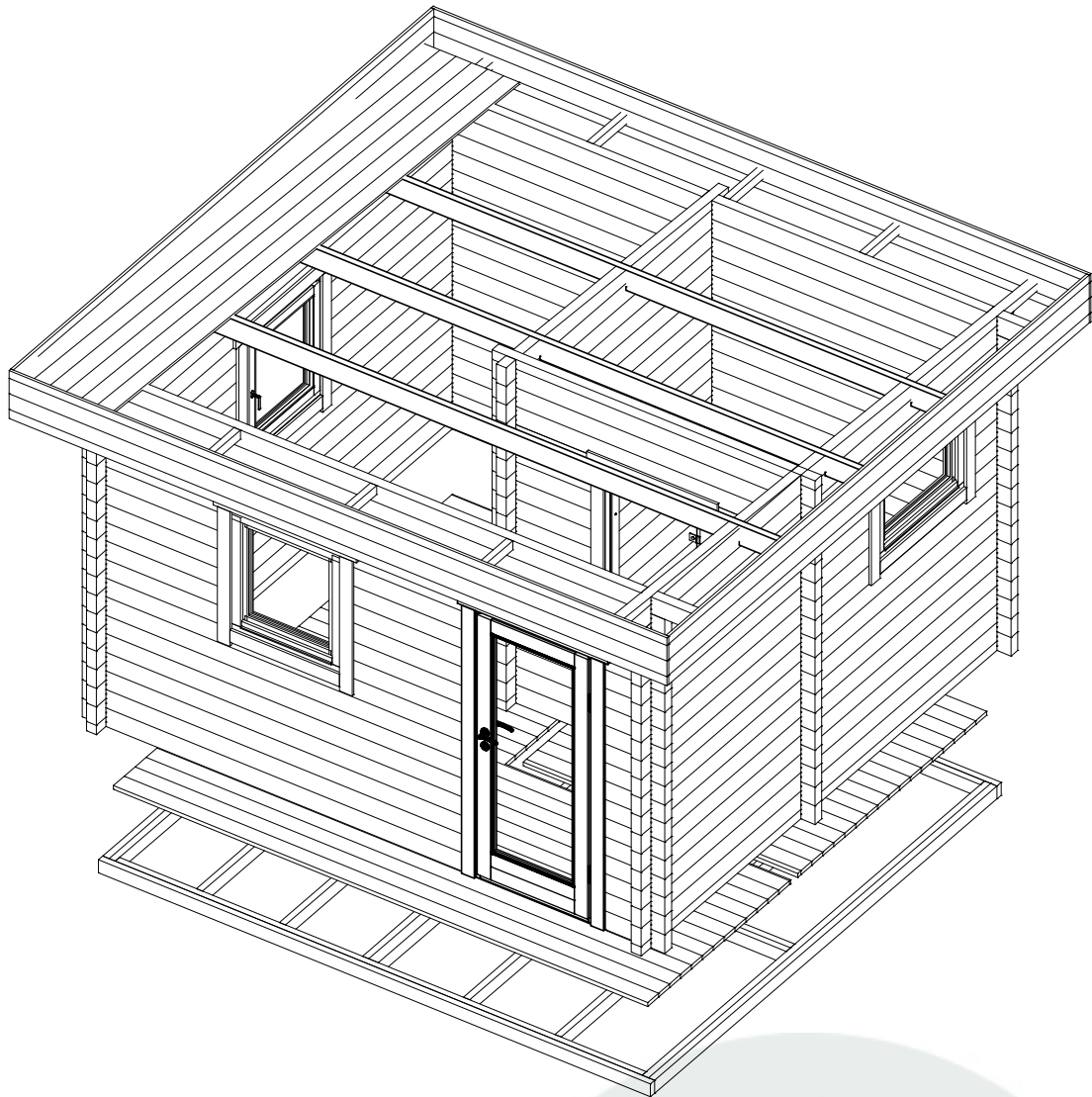

Grundriss 350195

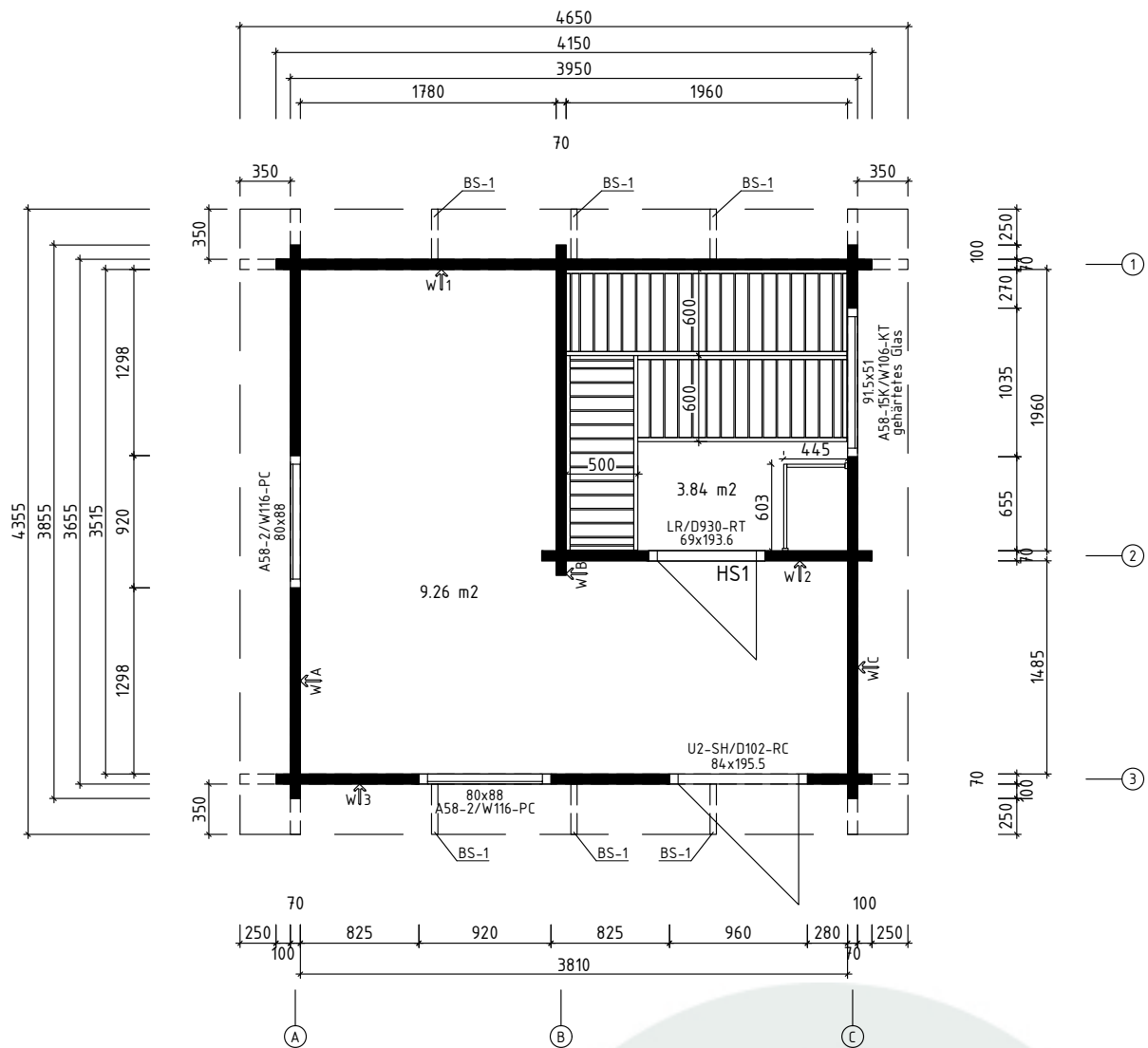

Q4 – Qualitätsklasse für Fenster und Türen

* Fenster und Türen sind ohne Sprossen

Lagerholzplan und Fundamentplan 350195

Wir empfehlen als Fundament für Ihr Gartenhaus eine vollflächig festgegründete, gepflasterte oder betonierte Fläche.
Wahlweise ist auch ein Punkt- oder Streifenfundament möglich.

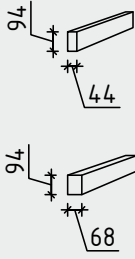
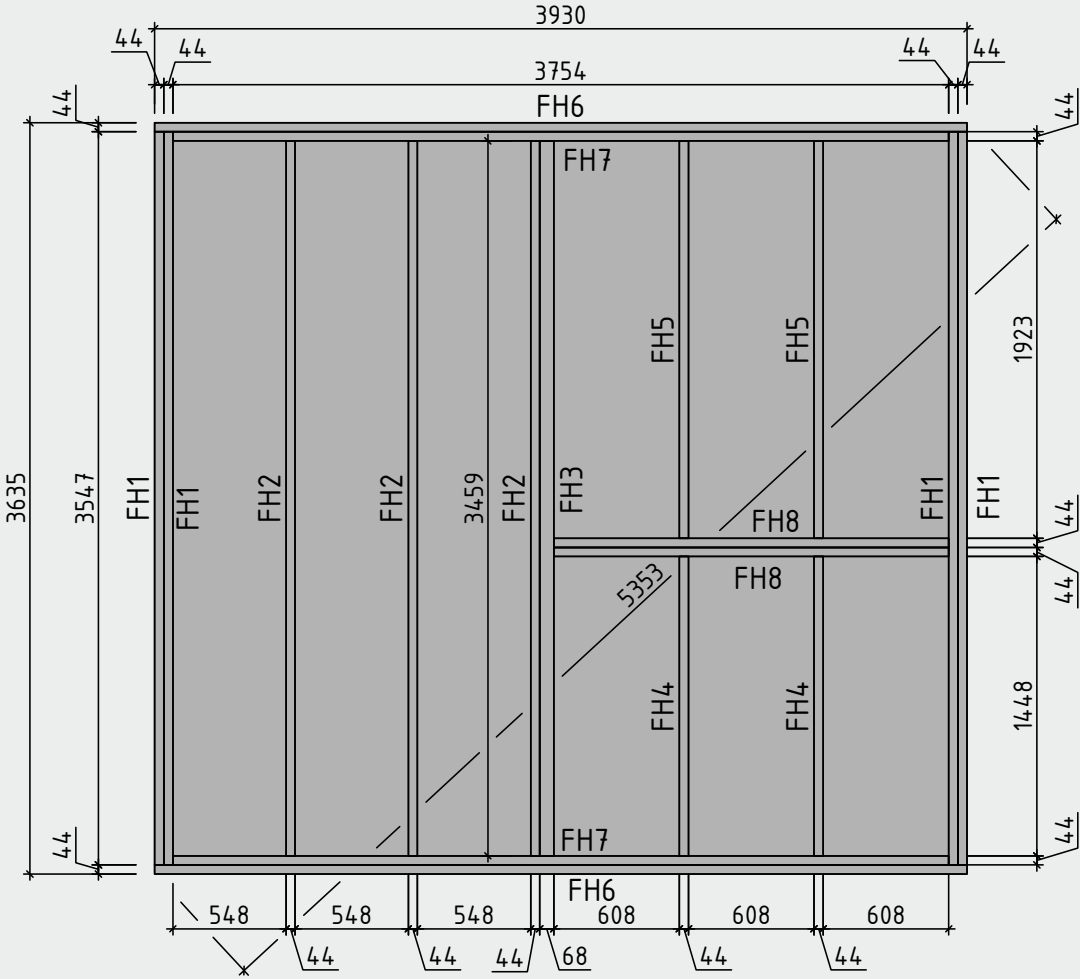











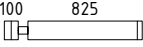
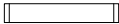
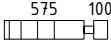
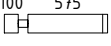

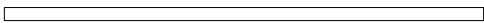

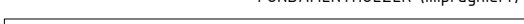



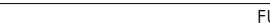

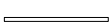
Teileliste 1

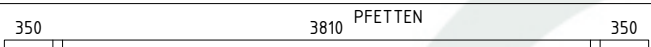
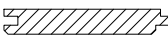
350195

Pos		Stck	Profil (mm)	Länge (mm)
001		1	70x123	4650
002		1	70x135	4650
003		1	70x135	4355
004		1	70x135	4355
005		3	70x135	4150
006		15	70x135	4150
007		2	70x135	4150
008		11	70x135	3855
009		1	70x135	3855
010		1	70x135	3855
011		1	70x68	3855
012		9	70x135	3855
013		1	70x135	3855
014		1	70x135	3855
015		1	70x68	3855
016		7	70x135	2740
017		1	70x135	2740
018		4	70x135	2380
019		1	70x135	2300
020		1	70x70	2300
021		20	70x135	2300
022		1	70x68	2300
023		1	70x68	1968
024		1	70x68	1905
025		12	70x135	1468











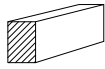





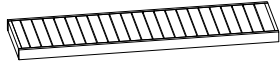
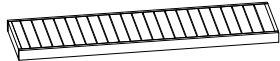
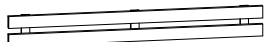

Teileliste 2

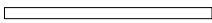
350195

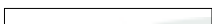
Pos		Stck	Profil (mm)	Länge (mm)
026		7	70x135	995
027		7	70x135	825
028		14	70x135	745
029		16	70x135	745
030		15	70x135	450
031		4	70x135	440
FH3	FUNDAMENTHÖLZER (imprägniert) 	1	68x94	3459
FH6	FUNDAMENTHÖLZER (imprägniert) 	2	44x94	3930
FH7	FUNDAMENTHÖLZER (imprägniert) 	2	44x94	3754
FH1	FUNDAMENTHÖLZER (imprägniert) 	4	44x94	3547
FH2	FUNDAMENTHÖLZER (imprägniert) 	3	44x94	3459
FH5	FUNDAMENTHÖLZER (imprägniert) 	2	44x94	1923
FH8	FUNDAMENTHÖLZER (imprägniert) 	2	44x94	1911
FH4	FUNDAMENTHÖLZER (imprägniert) 	2	44x94	1448
HS1	HOLZSCHWELLE (unter der Saunatur) 	1	75x28	750
PF1	PFETTEN 	2	44x145	4650
PF2	PFETTEN 	1	44x145	4650
	DACHBRETTER 	42+1	113x18	4260
	FUSSBODENBRETTER 	14+1	113x28	3805
	FUSSBODENBRETTER 	18	113x28	1955
	FUSSBODENBRETTER 	18	113x28	1775
	ABDECKLEISTEN 	✓	15x28	18,0 lfdm
	FUSSBODENLEISTEN 	✓	14x55	23,0 lfdm
BL-1	DACHBLENDEN 350mm 	2	18x350	4355
BL-2	DACHBLENDEN 350mm 	2	18x350	4686

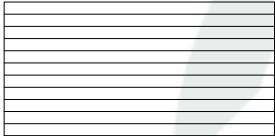

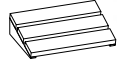







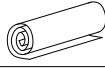



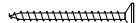

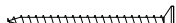
Teileliste 3

350195

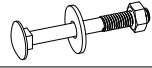
Pos			Stck	Profil (mm)	Länge (mm)
BS-1	DACHBLENDEN- Blendenstützen 44x65		6	44x65	350
UPB-1	DACHBLENDEN- U-Profil für Blenden		✓	65x44	19,0 lfdm
DPL-1	DACHPAPPENLEISTEN 15x28		✓	15x28	14,0 lfdm
T06-1	TRAUFENLEISTEN 18x40		✓	18x40	10,0 lfdm
TL70-1	T-LEISTE 70		2	45x70	490
TL70-2	T-LEISTE 70		2	45x70	760
TL70-3	T-LEISTE 70		2	45x70	895
TL70-4	T-LEISTE 70		4	45x70	1975
SA02-1	SAUNA - Saunabank 50cm		1	500x90	1355
SA01-1	SAUNA - Saunabank 60cm		2	600x90	1955
SA15-1	SAUNA - Rücklehne		2	40x250	1860
SA16-1	SAUNA - Bänke Zwischenstück		1	40x300	1955
SA10-1	SAUNA - Trägleiste für Saunabänke		✓	30x40	600
SA10-2	SAUNA - Trägleiste für Saunabänke		✓	30x40	1200
SA11-1	SAUNA - Stützpfeiler für Saunabänke		✓	44x65	500
SA11-2	SAUNA - Stützpfeiler für Saunabänke		✓	44x65	1000
SA20-1	SAUNA - Trägleiste für Deckenisolation		✓	35x35	2000
	DECKENISOLATION		2 Elemente		ca 1950x975
SA37	SAUNA - Bodenrost		1		
SA30	SAUNA - Heizung Umbau (set 1)		1		
SA35	SAUNA - Kopfstütze		2		
SA36	SAUNA - Luftschieber		3		
SH	Schlaghölzer		3		

Teileliste 4

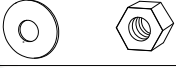
350195

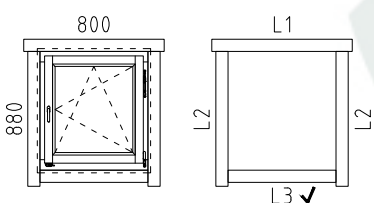
Pos		Stck.	Profil (mm)	Länge (mm)
KP-1	DACHPAPPE 	✓	5,4m-6st.	34,0 lfdm
NG01	DACHPAPPNÄGEL 2.8x15 	420		
NG04	NÄGEL 2.5x50 Dachbretter 	420		
SR4 210	SCHRAUBEN 4.2x55 C2 Fussbodenbretter Holzschwelle 	299		
SR32	SCHRAUBEN 3.0x30 Abdeckleisten, Fussbodenleisten Dachpappenleisten, Traufenleisten 40x18 Bänke Zwischenstück, Luftschieber 	154		
SR37	SCHRAUBEN 3.5x45 Heizung Umbau 	8		
SR3 550	SCHRAUBEN 3.5x45 C3 U-Profil für Blenden 	38		
SR3 550	SCHRAUBEN 3.5x45 C3 Fenster- und Türleisten 	112		
SR44	SCHRAUBEN 4.0x60 Trägleiste für Saunabänke Trägleiste für Deckenisolation, Rücklehne 	62		
SR57	SCHRAUBEN 5.0x100 Fundamenthölzer 	72		
SR55	SCHRAUBEN 5.0x70 Stützpfeiler für Saunabänke Blendenbefestigung 	62		
SA2 5-1	SAUNA - Dichtungsband für Deckenisolationselemente 	✓		8,0 lfdm
SS023	Schloßschrauben M8x70 Mutter M8 U-Scheibe Ø25 - Befestigung für Saunabänke 	2		
KL1	Gewindestange M8 	4		2000
KL2	Gewindestange M8 	2		583
KL3	Gewindestange M8 	2		460
	Mutter M8 U-Scheibe Ø25 	8		
	Befestigungsmutter M8 	4		
	FENSTER <u>Q4</u> W4-S70P-0XC-08000880 	2		
	A58-2 / W116-PC L1 18x90 L=1040mm 2x L2 18x90 L=1000mm 4x L3 18x90 L=800mm 2x ✓			

Teileliste 5

350195

Pos		Stck	Profil (mm)	Länge (mm)
	<p>FENSTER <u>Q4</u> W4-S70K-0XT-09150510</p> <p>A58-15K gehärtet/ W106-KT</p> <p>L1 18x90 L=1155mm 2x L2 18x90 L=630mm 4x L3 18x90 L=915mm 2x ✓</p>	1		
	<p>TÜR D0-L70R-0XT-06901936</p> <p>LR / D930-RT</p> <p>L1 18x90 L=930mm 2x L2 18x90 L=1935mm 4x ✓</p> <p>DIN rechts</p>	1		
	<p>TÜR <u>Q4</u> D4-S70R-0XC-08401955</p> <p>U2-SH (196) / D102-RC</p> <p>L1 18x90 L=1080mm 2x L2 18x90 L=1955mm 4x ✓</p> <p>DIN rechts</p>	1		
<p>Achtung Hinweis: wir empfehlen die Stromverkabelung für den Elektro-Saunaofen <u>vor</u> Verlegung von den Fußbodenbrettern durchzuführen.</p>				
	✓ - Bitte selber anpassen (falls nötig)! / Cut into length on site (if needed)!			

Wandplan 1 und 2

350195

Die Bohlen mit Lüftungsöffnungen können je nach Bedarf höher oder niedriger eingesetzt werden. Bitte achten Sie darauf dass die Lüftungsöffnungen von innen nicht mit der Saunabank bedeckt werden!

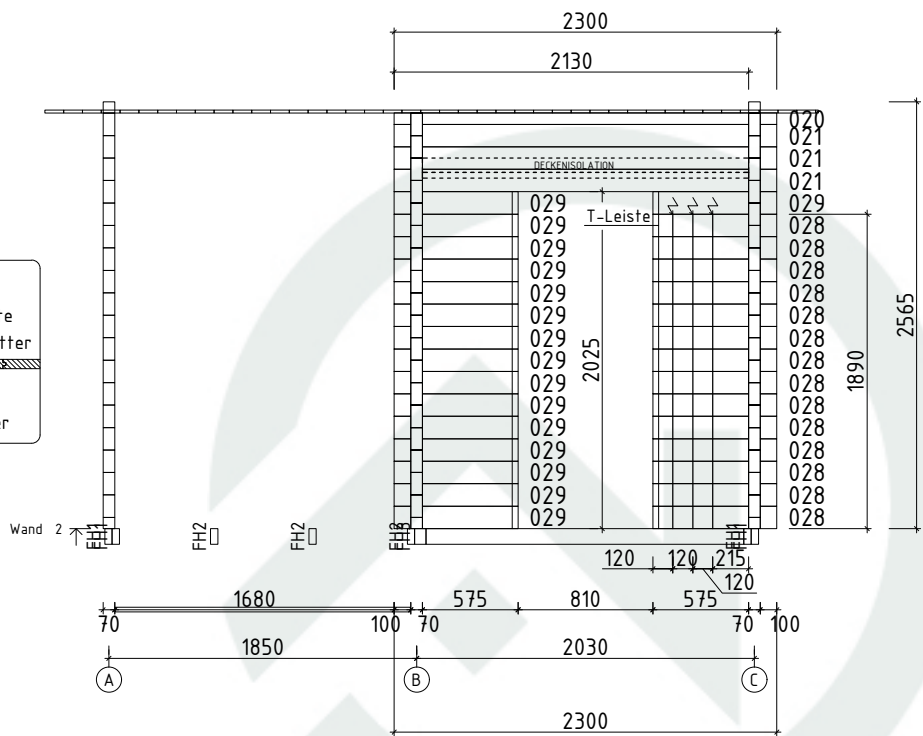
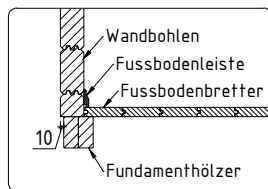
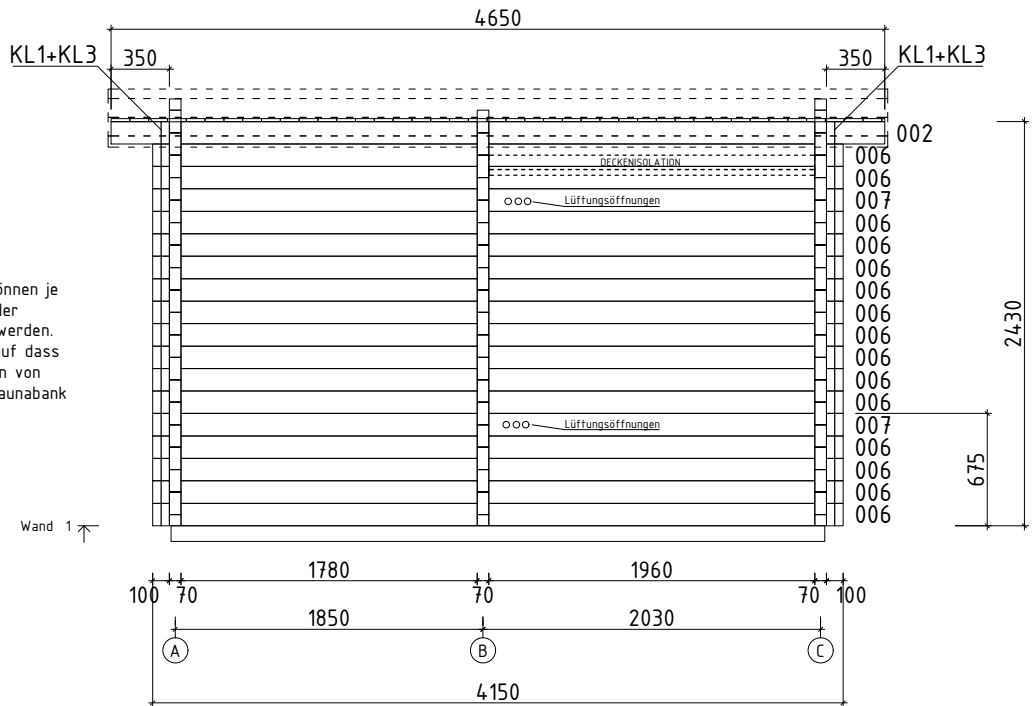

↘ -Bohrung für elektrische Kabel

Wandplan 3 350195

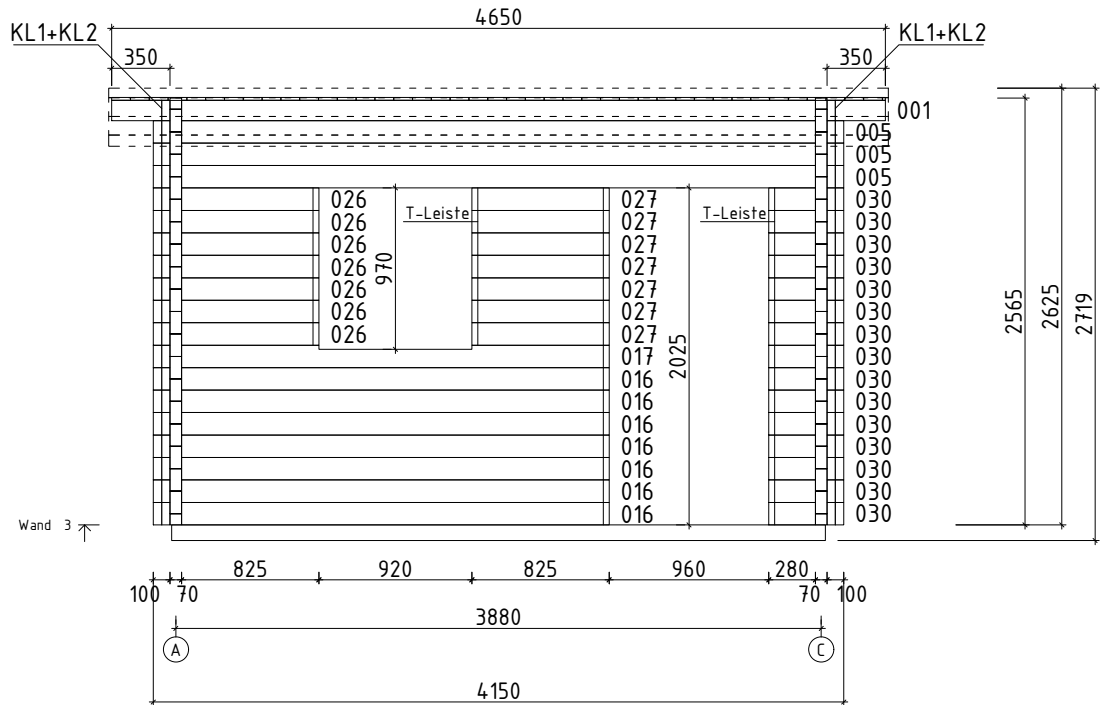

Wandplan A und B 350195

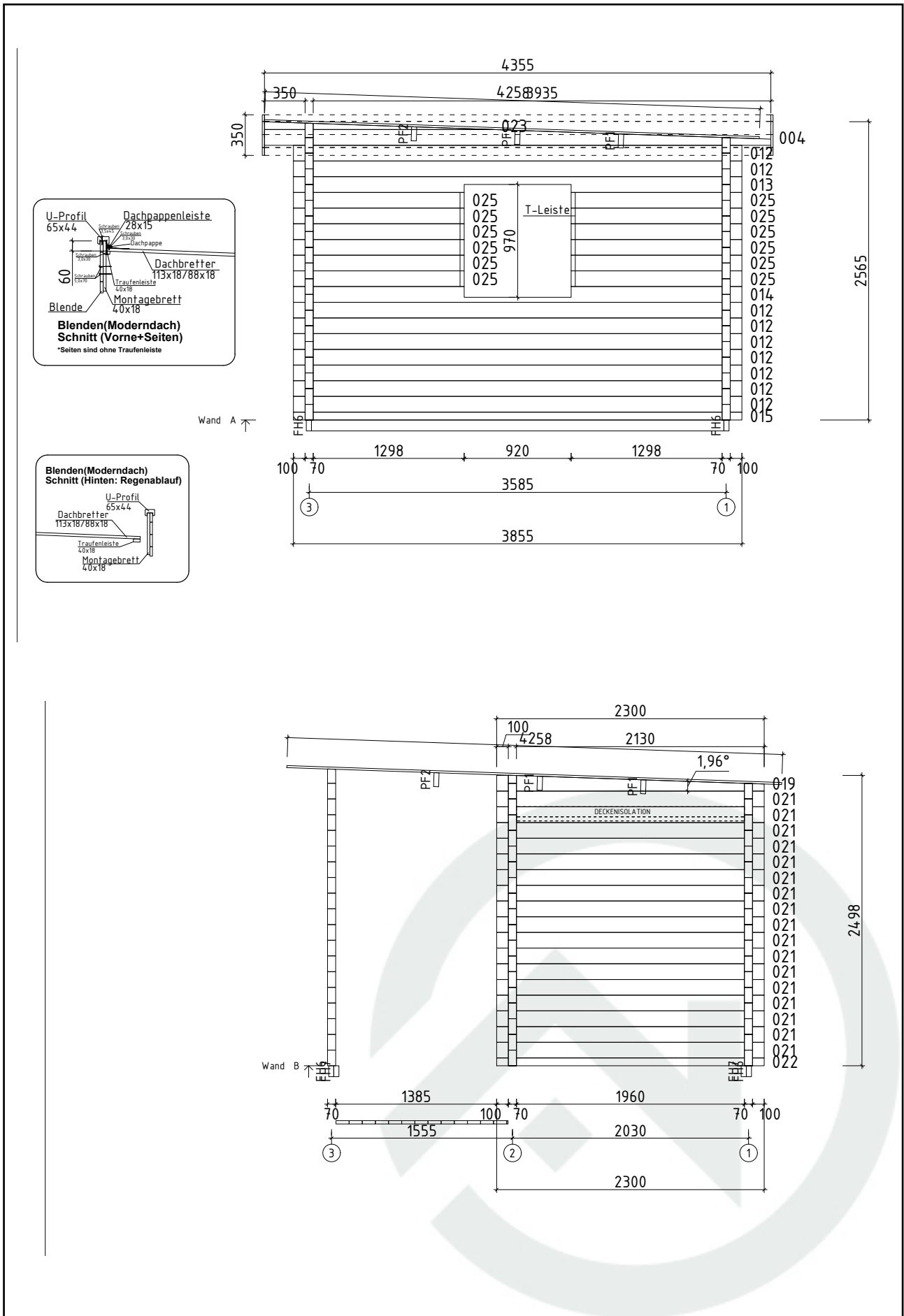

Wandplan C

350195

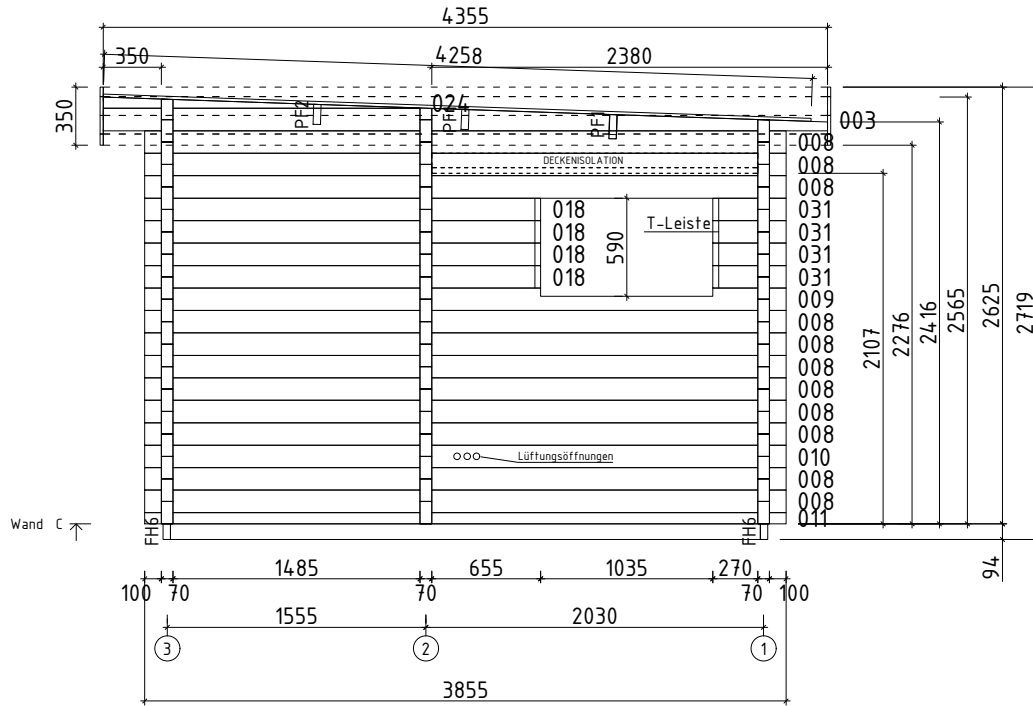

Die Bohlen mit Lüftungsöffnungen können je nach Bedarf höher oder niedriger eingesetzt werden. Bitte achten Sie darauf dass die Lüftungsöffnungen von innen nicht mit der Saunabank bedeckt werden!

Details / optional

350195

Montageanleitung für T-Leisten / Installing the door and window supports / Tenderliistu paigaldusjuhend.

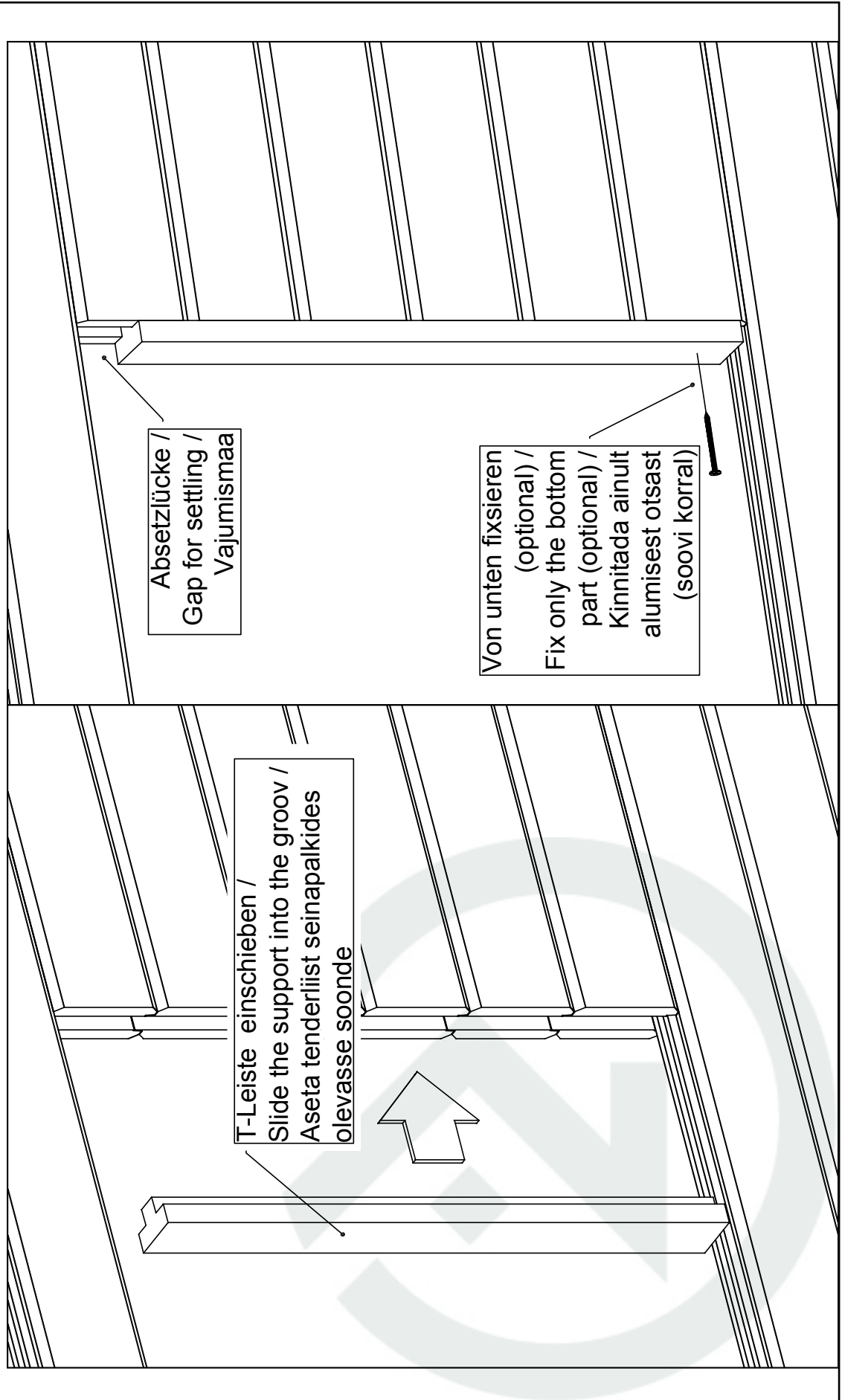

Details / optional

350195

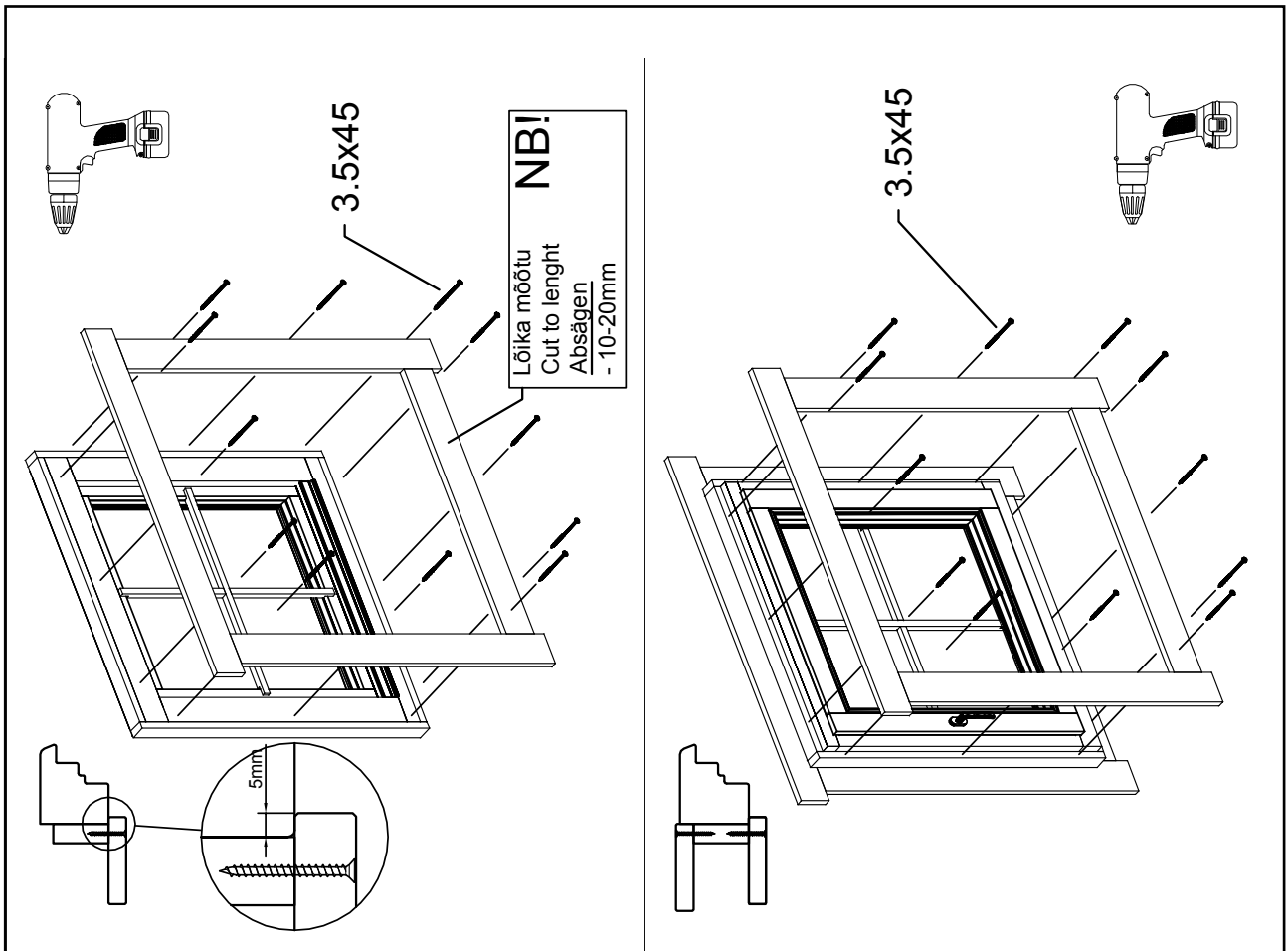

Akna tüüp / Fenster typ / Window type - A68
(GH+ / SH)

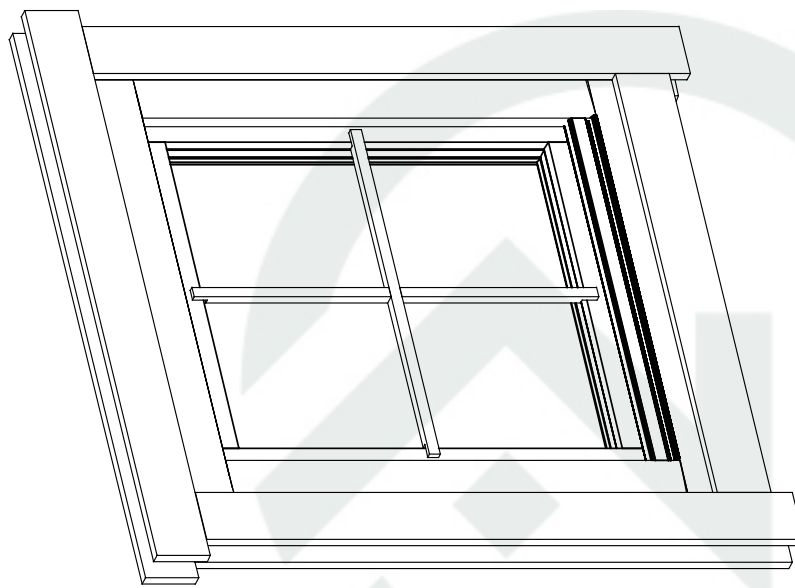

Details / optional

350195

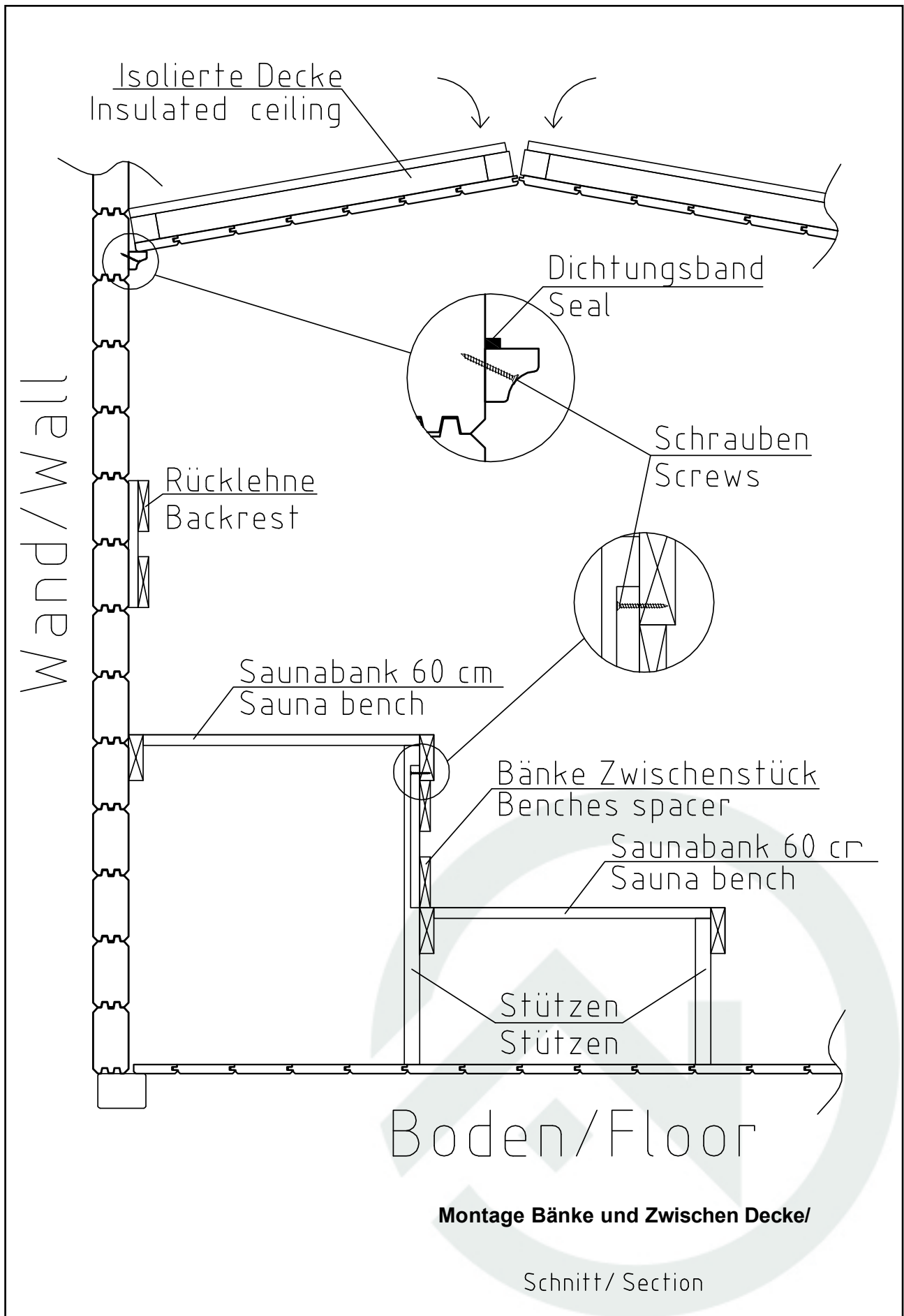

Details / optional

350195

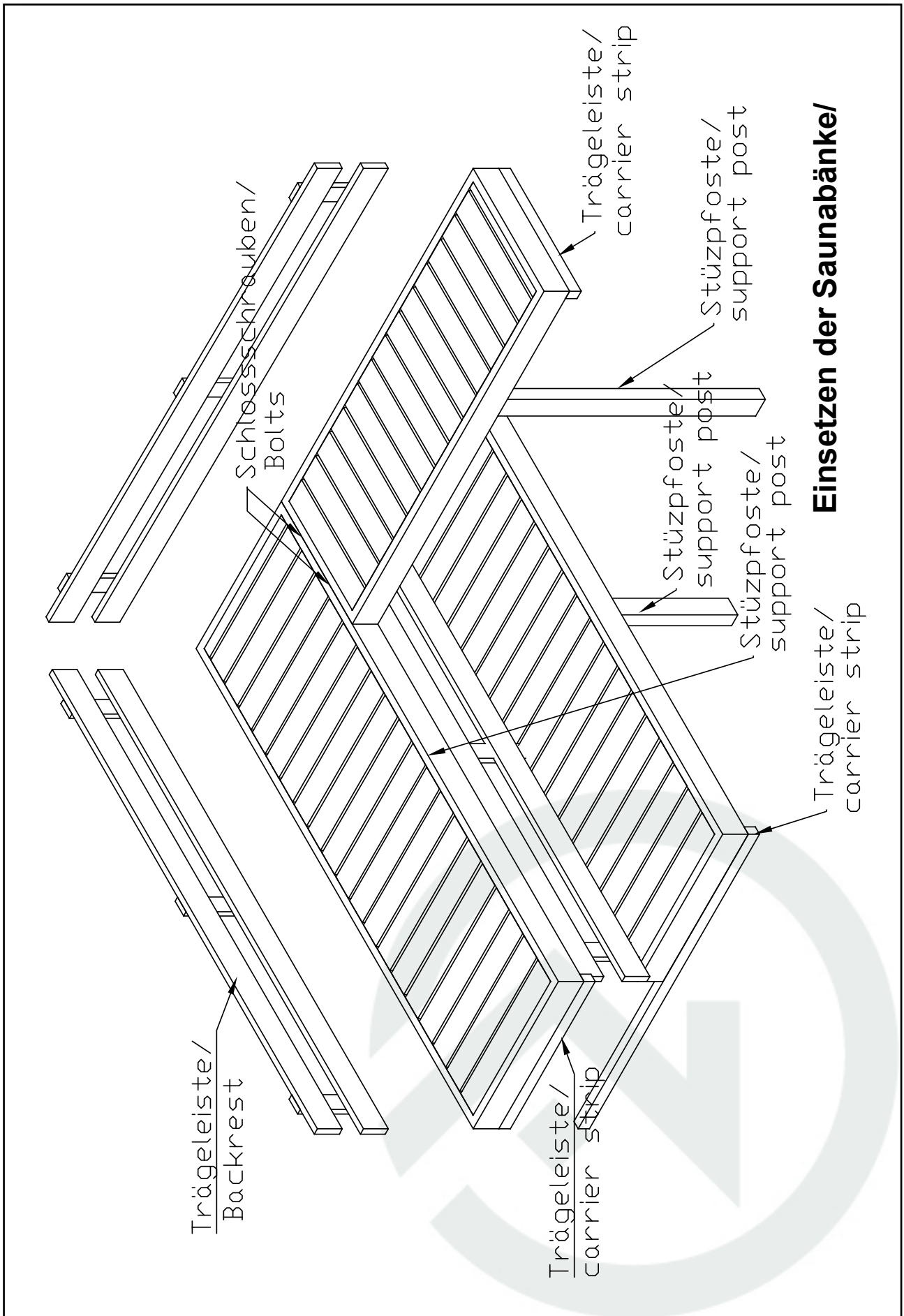

Details / optional

350195

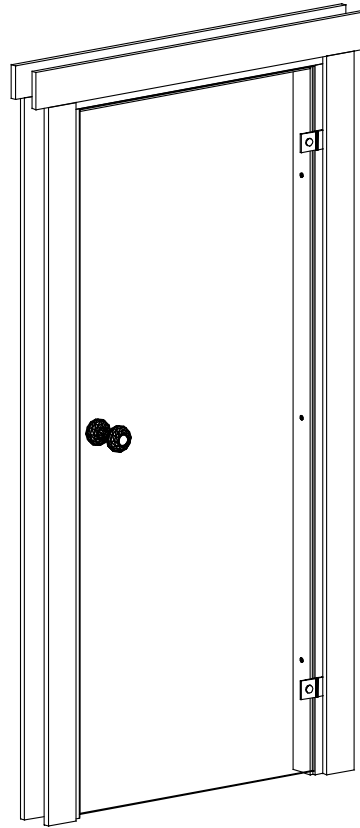

18x90 Blendleisten/
cover strips/piirdeliistud

Rahmenleisten
20x Wandstärke/
frame extensions
20x wall thickness/
laiendusliist
20x seinä paksus

18x90 Blendleisten/
cover strips/piirdeliistud

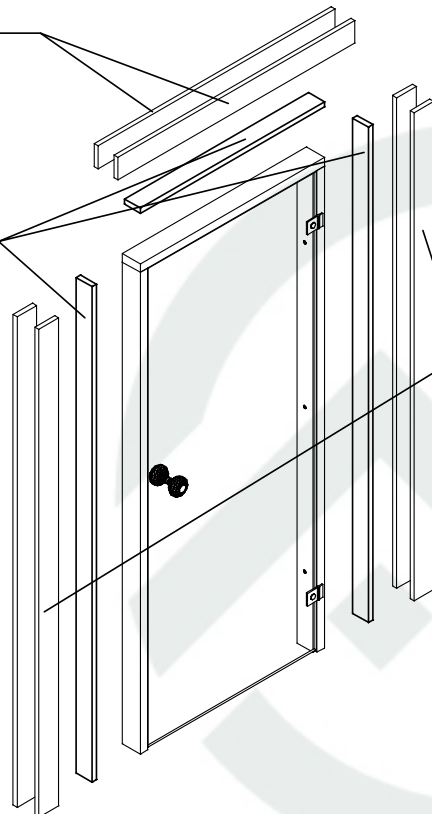

Details / optional

350195

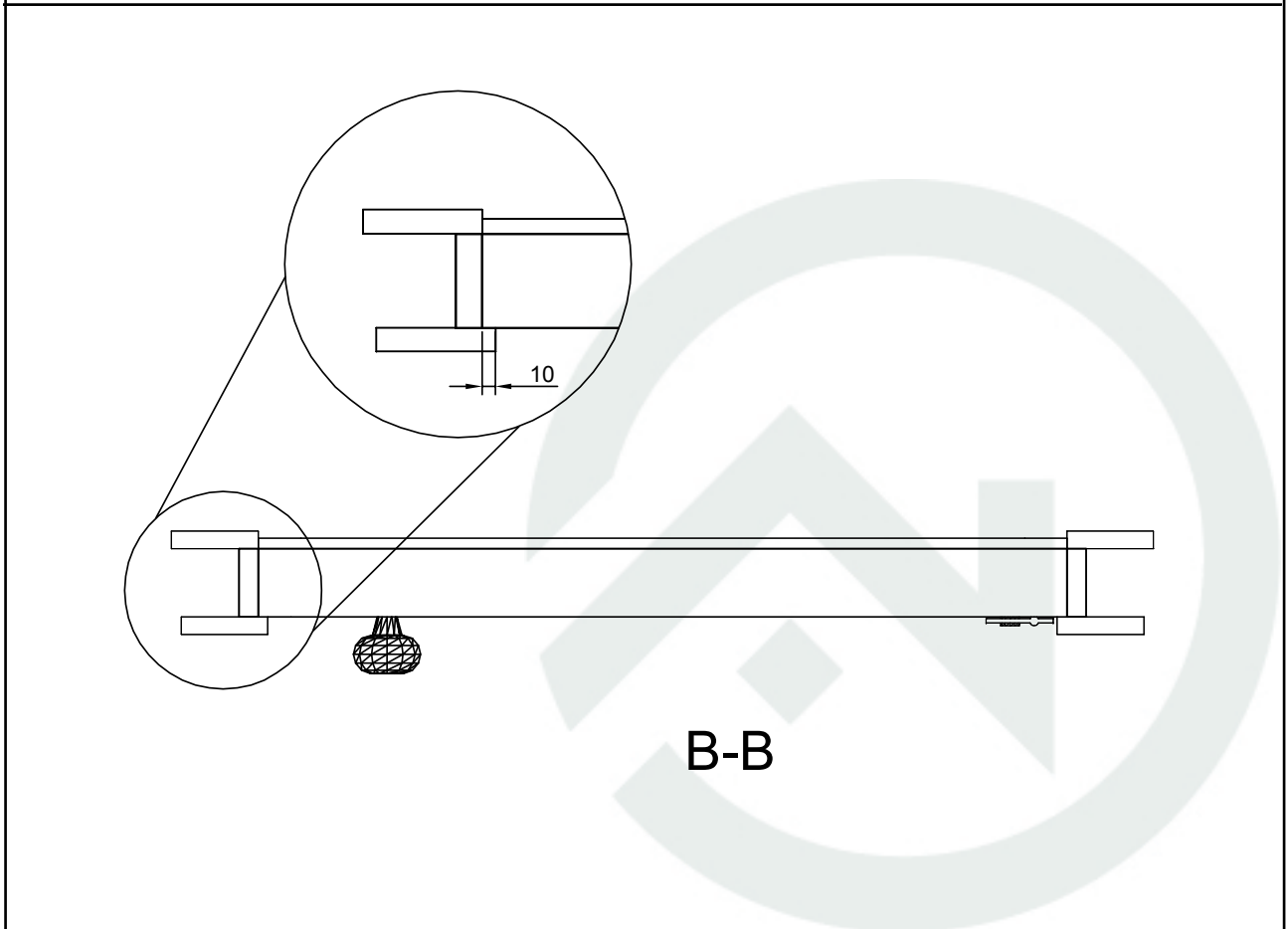
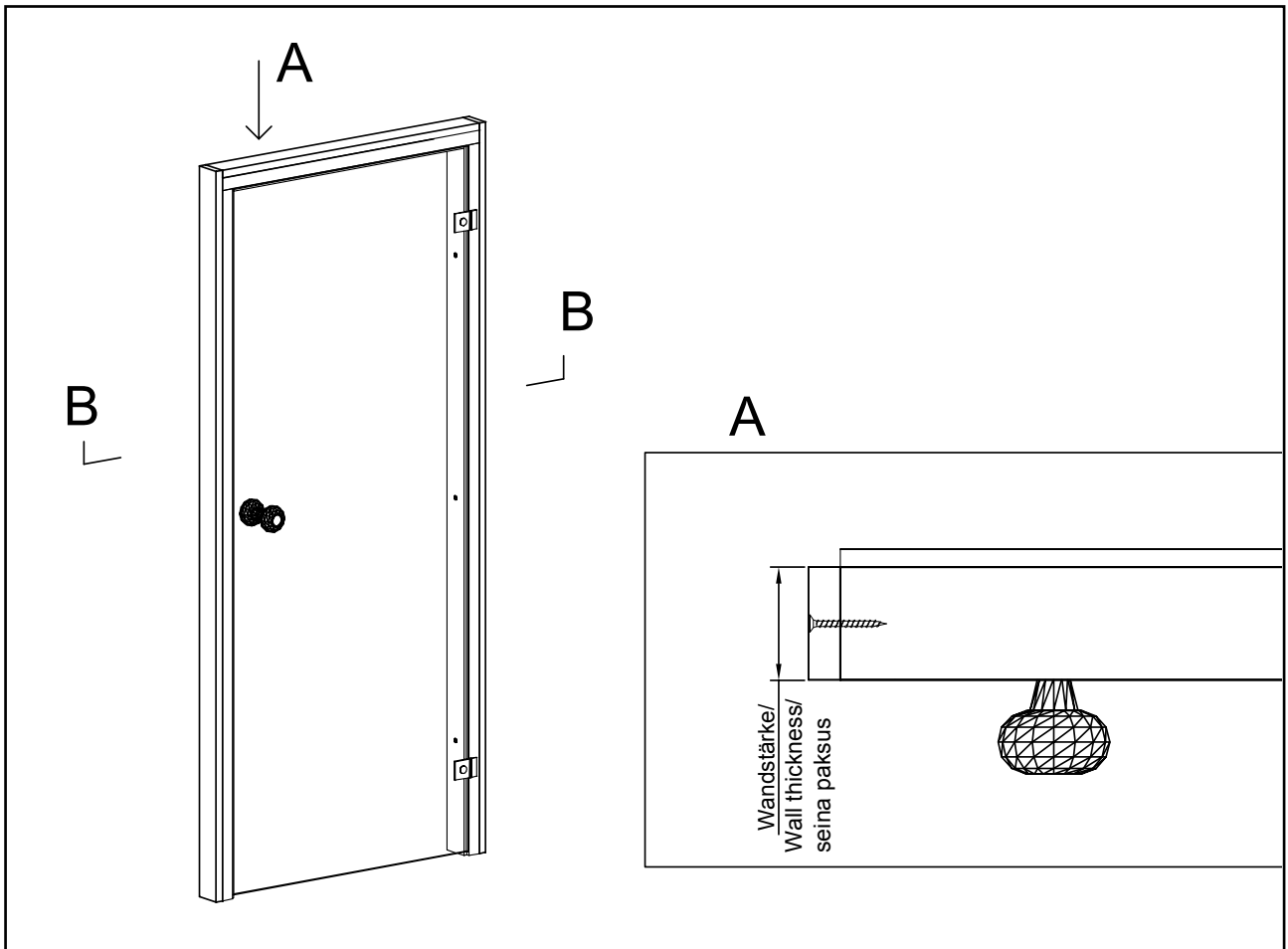

Details / optional

350195

