

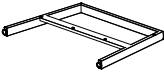











A		1
B		1
C	 M6*32	4
D	 Ø13*Ø6.5*1.0	4
E		1
F		1

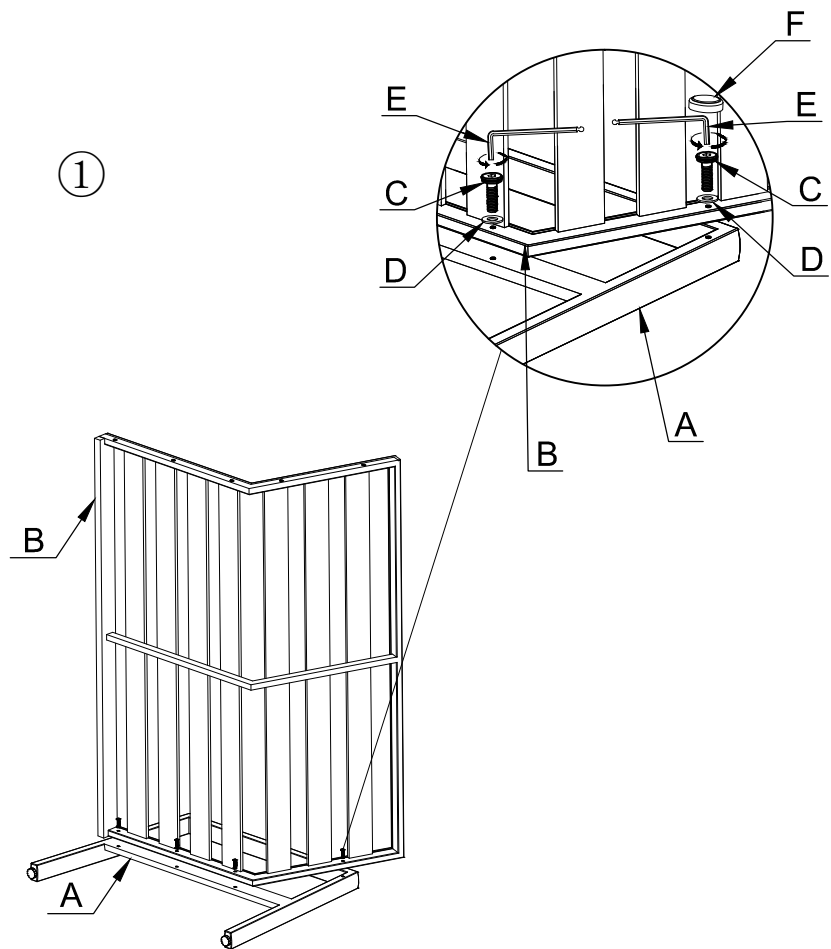

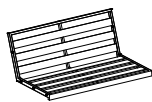
A		1
B		1
C	 M6*32	4
D	 Ø13*Ø6.5*1.0	4
E		1
F		1

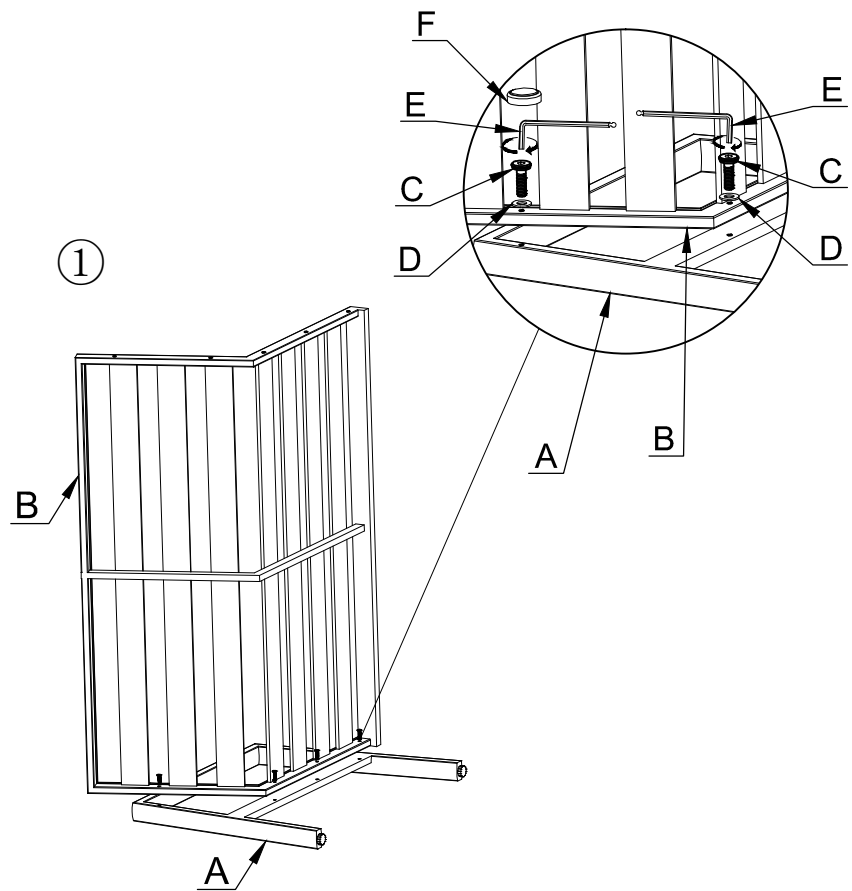

A		1
B		1
C		1
D	 M6*52	10
E	 Ø13*Ø6.5*1.0	20
F		10
G		1
H		1
J		4
K		4
M		4
N		4
Q		1
R		1
S		1

